



# ACD® PRESTIGE

*The groovy greenhouse 2015*

**Import remark**

This export catalogue is based on the consumer catalogue for Belgium, the Netherlands, Luxemburg and France.

The product related information is subject to variations, a.o. in terms of guarantee, prices, assembly, delivery etc. according to the country where the catalogue shall be distributed.



Become fan and discover the scoops on  
[Facebook.com/ACDserres](https://www.facebook.com/ACDserres)



[@ACDserres](https://twitter.com/ACDserres)

[www.acd.eu](http://www.acd.eu)

## A 'PRESTIGE' FOR EVERY GARDEN



**Product range** page 1

**Characteristics of ACD®PRESTIGE** page 2-7

**Nursing tray** page 8

### Action models

Piccolo	page 9
R204L-B	page 11
R305H-B	page 13
R307H-B	page 15
S104H-B	page 17
S106H-B	page 19
S208H-B	page 21
R205H-Retro	page 23
R306H-Retro	page 25
R405H-Retro	page 27

### Combo

R205H-Combo	page 29
R305H-Combo	page 30
R306H-Combo	page 31
R307H-Combo	page 32

**Garden room - NEW** page 34

**Options** page 39-43

**Wooden floors** page 43

### All models

Greenhouse with straight walls	
R1 Length 2.02m / High	page 45
R2 Length 2.32m/ Low	page 46
R2 Length 2.32m/ High	page 47
R3 Length 3.06m/ Low	page 49
R3 Length 3.06m/ High	page 50
R4 Length 3.80m/ High	page 51
Greenhouse with sloping walls	
S1 Length 3.06m/ High	page 53
S2 Length 3.80m/ High	page 54
S3 Length 4.53m/ High	page 55
Lean-on greenhouse with straight walls - <b>NEW</b>	
MR2 Width 1,55m/High	page 57
MR3 Width 2,29m/High	page 58
Lean-on greenhouse with sloping walls	
MS1 Width 1,99m/Low	page 59
MS2 Width 2,28m/High	page 60
MS3 Width 3,02m/High	page 60

**Terms and conditions** page 61-63

**ACD® - grow, store, experience** page 64

ACD® PRESTIGE features **sustainability, quality and service.**

Benefits galore:

- ✓ **ultra-sturdy construction:** an **enclosed, tubular ridgepole; enclosed industrial glazing bars;** sturdy corner profiles; aluminium corner plates; wind reinforcement profiles in roof, front, back and side walls; ground anchors, etc. Top-quality design for the longest useful life, maintenance free.
- ✓ delivered with a **self-supporting aluminium base with double sheath** as a standard feature, **avoiding the need for concrete foundations**
- ✓ we use only **stainless steel** nuts and bolts
- ✓ all our greenhouses have an **outer and an inner condensation gutter**
- ✓ each greenhouse is fitted with 4 mm **horticultural glass** or 4 mm **safety glass.**  
We are trendsetters in the field of safety glass, which complies with the European standard EN12150
- ✓ the roof has (mat) **hammered glass** as a standard feature
- ✓ air and water-tight thanks to the use of **rubber strips** in the glazing
- ✓ volume: tall models ensure more room for growth and additional working comfort, bearing in mind the importance of economically responsible heating
- ✓ **12-year guarantee** on expertise and materials (see page 5)
- ✓ very wide range of **accessories and options** so that you can use your greenhouse all year round, season after season. Includes automatic window openers, screen door, choice of worktables, etc.
- ✓ **strong local network** of trained ACD dealers to offer you maximum service and support
- ✓ **free home delivery**
- ✓ **assembly:** you can either erect the greenhouse yourself (with the help of a detailed manual) or have it assembled by our specialists



**TIP!** Mounting set

- ✓ all greenhouses are available in **all RAL colours** as an option, except for the metal colours
- ✓ ACD® exclusivity: greenhouses with **sloping walls**, offering the benefits of improved light and heat absorption, reduced wind pressure and a stable construction

# Quality down to the smallest detail

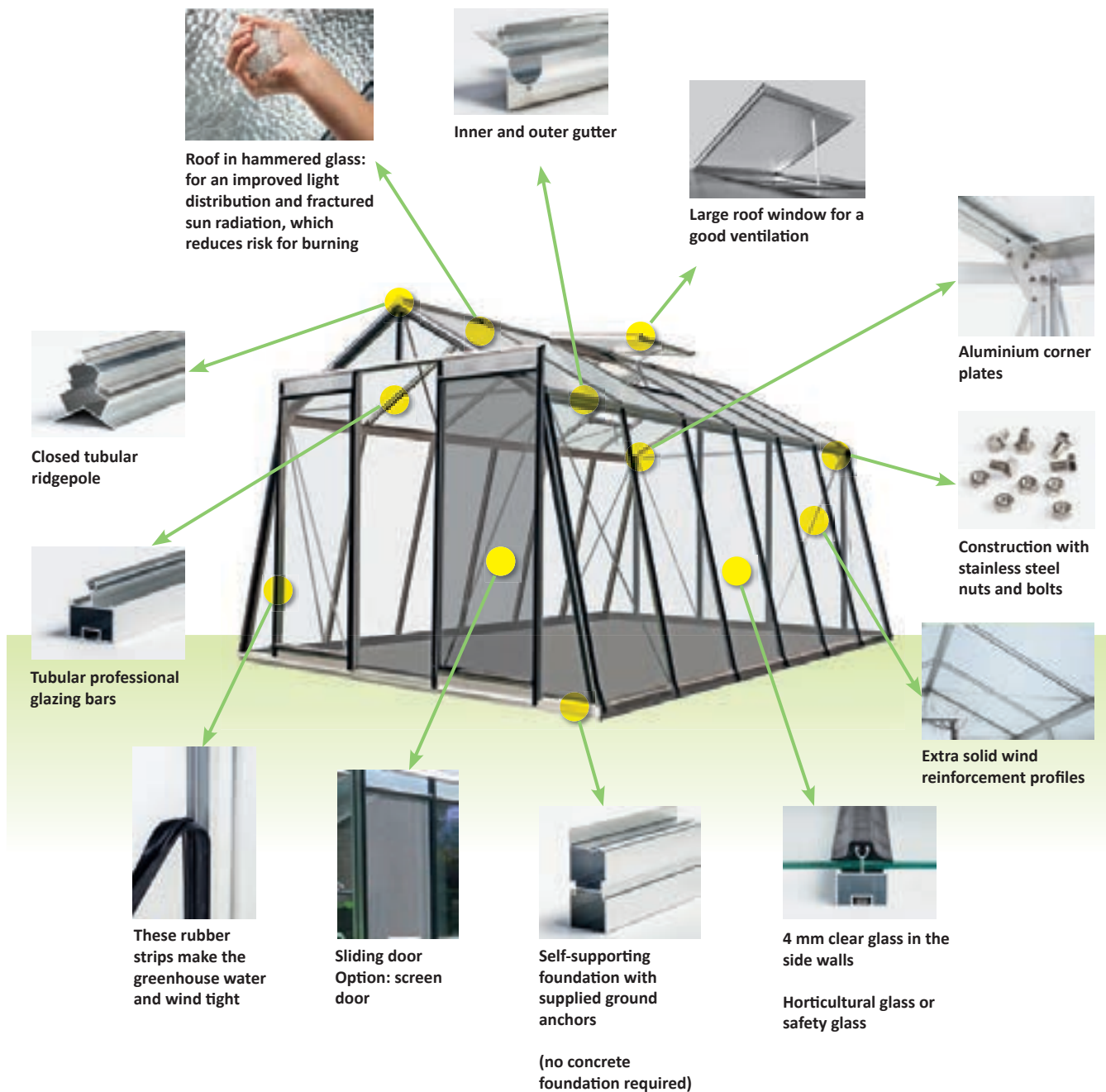

**ACD® PRESTIGE**



**Rigid, maintenance free aluminium construction**



## The quality of an ACD® PRESTIGE from ridge to foundation:

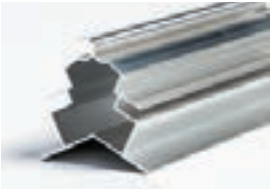

**Closed, tubular ridgepole:** this ridgepole contributes to a highly sturdy construction: no impact from wind, pressure and weight! This profile is the very backbone of your greenhouse

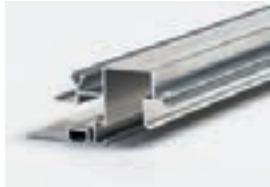

**Professional corner profiles:** these columns support the entire construction and have been extensively tested on both solidity and aesthetics

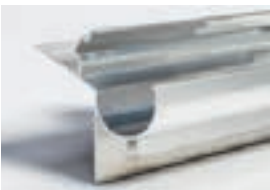

**Outer gutter and condensation gutter:** the inner gutter enables a quick evacuation of condensation water, reducing the risk of algal bloom and mildew



Complete construction of the ACD® PRESTIGE greenhouse with **stainless steel nuts and bolts** = solid and stainless steel assembly



**Aluminium corner plates** contribute to a better assembly of the roof. The roof of the ACD® PRESTIGE greenhouse is additionally attached to the front, back and side walls with aluminium corner plates in the 4 corners of the gutter and to the 2 ends of the ridge. This gives full strength to the entire greenhouse construction.

**Extra sturdy wind reinforcement profiles** in the front and back sides, side walls and roof, already attached at fixed points: extra safety in case of heavy wind blasts.



**Self-supporting aluminium foundation profile** with supplied ground anchors. This extremely solid **dual chamber** profile protects your greenhouse against all possible ground pressure (dammed-up ground water due to frost, subsidence during dry periods). **NO CONCRETE FOUNDATION REQUIRED !!**

Extra benefits:

- ✓ **time saving:** this foundation replaces all concrete, stone or plate foundations;
- ✓ **easy assembly:** no more preparation required. You erect your greenhouse directly on the soil;
- ✓ **the soil** in the greenhouse **remains in connection** with the outer soil of the greenhouse: acids and salts can be evacuated easily.

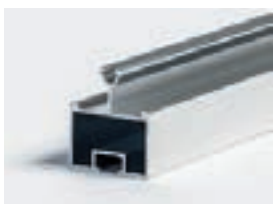

**Tubular professional glazing bars.** These industrial ACD® PRESTIGE profiles support the weight of the glass and form a solid and tight construction.



Each greenhouse is fitted with 4 mm horticultural glass or 4 mm safety glass. Standard features of every greenhouse are: roof in hammered glass, front, back and side walls in clear glass. Modifications of this glass combination subject to supplement.



The ACD® PRESTIGE greenhouses come **with hammered glass in the roof** as a standard feature. This is unique! Many manufacturers offer it as an option, due to the important additional charges for this glass type. Yet, this hammered glass offers the major benefit that sun radiation is fractured, reducing the risk of burn in the greenhouse.

The hammered glass also improves the distribution of light, making plants grow better and stronger.



ACD permanently improves the quality of the ACD® PRESTIGE greenhouses.

The option **safety glass** (tempered glass) is now available on all models, the option for action models being offered against very advantageous conditions. Safety is a major issue. Please refer to p. 7. In case of breach, this safety glass is fragmented into utterly small, relatively harmless pieces. Both clear and hammered glass are tempered.



**Rubber strips:** 'the' professional system in the ACD® PRESTIGE greenhouse for a perfect assembly of the glass. These rubber strips contribute in a very simple way to water and wind tight assembly.







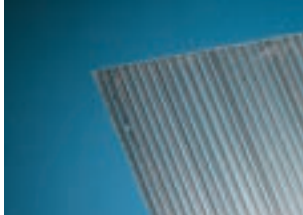

**Ventilation:** each ACD® PRESTIGE greenhouse is sufficiently ventilated with 1 or more roof windows and features a high and wide door opening. The number of roof windows depends on the length of the greenhouse. Extra roof windows are an option. Each greenhouse can also be fitted with a screen door.

## GUARANTEE:

Each ACD® PRESTIGE greenhouse comes with a **12 years phasing out guarantee** on production defaults, if any. All moving parts (door wheels, hinges, etc.) are subject to a 1 year phasing out guarantee. We replace free of charge every part which does not meet our high standard requirements. The guarantee includes all possible damage due to material and manufacturing defaults. The guarantee includes only the material cost and excludes the labour costs. This guarantee is granted to the original owner and is not transferable. The guarantee excludes all damage resulting from undue or unjustified use or damage resulting from nature related exceptional situations. Glazing (glass and/or polycarbonate) falls beyond the guarantee.

## ACD® goes for safety glass

FILM	POLYCARBONATE	HORTICULTURAL GLASS	SAFETY GLASS
			
			
<p>The cheapest greenhouse construction</p> <p>Ideal protection against the wind</p> <p>Quick warming of the soil during spring, enabling early planting or sowing</p> <p>Ideal for unheated presowing</p> <p>Light, hence easily transportable and moveable</p>	<p>Light material</p> <p>Easy assembly</p> <p>Almost unbreakable</p> <p>Excellent insulation, according to the thickness of the plates</p> <p>A more constant temperature</p> <p>Diffuse light with fewer risks for burning</p> <p>Low energy cost</p> <p>Longer gardening season</p> <p>Very impact resilient</p> <p>Safe during assembly</p> <p>Safe for playing kids</p>	<p>Maximal light transmittance: up to 90 % of the available light</p> <p>Glass captures the solar warmth</p> <p>Glass does not age</p> <p>Condensation water runs down alongside the glass, without dropping water droplets on the plants</p> <p>Excellent resistance against scratches, corrosion, atmospheric and chemical impact, detergents and acid rain</p> <p>The combination of glass/ aluminium confers extra solidity to the greenhouse</p> <p>Glass can be recycled</p> <p>Hammered glass in the roof breaks the solar radiation, decreasing risk of burning + improving light distribution</p> <p>Cost efficient investment</p>	<p>All benefits of horticultural glass, plus:</p> <p>tempered according to the European tempering standard EN12150: please refer to p. 7</p> <p>7 x stronger than horticultural glass, 5 x stronger than float glass: important in case of hail, during work in the greenhouse, falling branches, snow charge,...</p> <p>Safe during the assembly</p> <p>Safe for playing kids</p> <p>In case of breach, the glass is fragmented into tiny, relatively harmless pieces (cf. car glass)</p> <p>Maximal longevity</p> <p>Maximal safety</p> <p>Hammered glass also comes with tempered glass</p> <p>Increased price/quality ratio</p> <p>No sharp edges</p>
			
<p>Limited life time (depending on thickness of the film, the UV-resilience, the location (protected or not), the rigidity with which the film is stretched, etc.)</p> <p>Impaired light transmittance on the long term</p> <p>Condensation water is not evacuated and drops may fall on the plants</p>	<p>Limited light transmission (plates tend to 'brown' after some time)</p> <p>Condensation and algal bloom in the plates is possible</p> <p>Subject to ageing signs</p> <p>Flexible and light, with the risk that the plates are tilted out of the frame during wind blasts</p> <p>More expensive</p> <p>Insulation (K-value) according to thickness</p> <p>The thicker the plate and the wider the channels, the more expensive</p>	<p>Breakable, in large and sharp pieces</p> <p>Weight (a solid frame is required)</p> <p>Difficult to move</p> <p>Sharp edges</p>	<p>More expensive than horticultural glass</p> <p>Impossible to cut</p> <p>Weight (requires a solid frame)</p> <p>Difficult to move</p>



## Characteristics of safety glass (tempered glass):



Traditional glass, horticultural glass or float glass have sharp edges and breaks into large, sharp pieces. **That is why more and more people go for safety glass.**

The thermally tempered glass used by ACD® is also safety glass according to the EN 12150 standard, since it fragments into different tiny pieces that are less sharp. The tempering process triggers high tension in the glass and results in a **double advantage**: it improves not only the **mechanical strength** (7 x stronger than horticultural glass, 5 x stronger than float glass), it also changes the **cracking mode of the glass**. The risk for incision wounds is minimised as the glass is fragmented into tiny, relatively harmless pieces.

## IMPROVED HAIL RESISTANCE

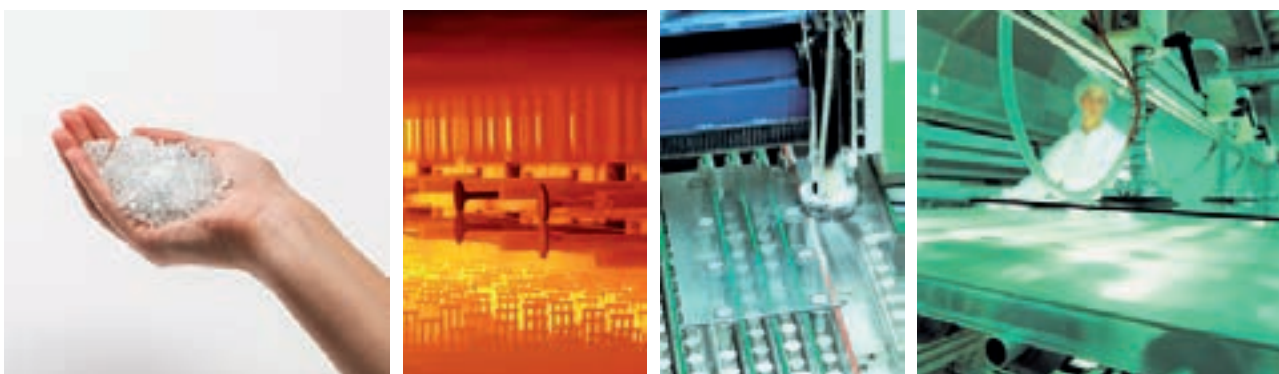

### BENEFITS:

- European standard: EN12150
- 7 x stronger than horticultural glass / 5 x stronger than float glass
- increased security during assembly:
  - o no sharp edges
  - o reduced risk for breaking
- safer for children and domestic animals and while you are working in the greenhouse
- in case of breach, the glass is fragmented into very tiny pieces and protects people and animals from incisions
- **increased protection against hail, snow load, falling branches, etc.**
- less risk for breach during transport

# ACD<sup>®</sup>PRESTIGE professional nursing trays

## **This is the ultimate nursing tray for the real fancier.**

The cover is absolutely professional, including sliding windows (patent granted) that guarantee an ideal ventilation. The windows are very easy to open and to close.

The sliding system makes sure that the windows can never be blown out!

The professional nursing trays are the ideal instrument both to anticipate and to prolong your summertime and even to protect your plants during the fall!

The professional nursing trays are a must-have for the real nurseryman!



## **Material**

The side walls are made of double-walled, transparent polycarbonate panes, with a thickness of 16 mm. The cover is made of 4 mm safety glass. The height of the front and the back side is respectively 35 cm and 45 cm.

## THE PACKAGE:

**FREE home delivery**

**12 year guarantee**

**Panes in safety glass**

**Delivery term 5 weeks, 7 weeks in RAL colour, + 2 weeks assembly by ACD**

## **References**

Art. 227200: **Professional nursing tray 4,07 m<sup>2</sup>**: 140 cm x 291 cm (4 panes on 2 rails) cover + sidewalls

Frame in alu: Frame in RAL colour:

Art. 227400: **Professional nursing tray 6,12 m<sup>2</sup>**: 140 cm x 437 cm (6 panes on 3 rails) cover + sidewalls

Frame in alu: Frame in RAL colour:

Art. 227600: **Professional nursing tray 8,02 m<sup>2</sup>**: 140 cm x 573 cm (8 panes on 4 rails) cover + sidewalls

Frame in alu: Frame in RAL colour:

There is a possibility of ordering only the cover when you make the construction of the side panels yourself (e.g. in concrete or wood).

Art. 227100: **Cover for the professional nursing tray 140 x 291 cm**

Frame in alu: Frame in RAL colour:

Art. 227300: **Cover for the professional nursing tray 140 x 291 cm**

Frame in alu: Frame in RAL colour:

Art. 227500: **Cover for the professional nursing tray 140 x 291 cm**

Frame in alu: Frame in RAL colour:

## **Options:**

Assembly by ACD

## ACTION MODEL **PICCOLO**



RAL 5024 - PASTEL BLUE



ALUMINIUM



RAL 3002 - CARMINE RED



RAL 1020 - OLIVE GREEN



RAL 9005 - RETRO BLACK

### SPECIFICATIONS

- Surface 3,56 m<sup>2</sup>
- Width 159 cm
- Length 224 cm
- Height of gutter 179 cm
- Height of ridge 221 cm
- 1 door
- 1 roof window
- Door opening 161 x 66 cm

With 4 mm horticultural glass

Aluminium frame  
Frame in RAL colour

With 4 mm safety glass

Aluminium frame  
Frame in RAL colour

The greenhouse is delivered as a do-it-yourself pack. Clear instructions guide you throughout the easy assembly of this greenhouse, unless you have your greenhouse assembled by ACD.

### Options:

- greenhouse assembly by ACD
- assembly of greenhouse accessories by ACD

### THE PACKAGE:

- FREE home delivery in a DIY kit**
- Roof in hammered glass**
- Self-supporting aluminium foundation with anchors**
- 12 year guarantee**
- Delivery term 3 weeks after order receipt,**
- 5 weeks in RAL colour, + 2 weeks assembly by ACD**

art.	description	in alu	in RAL colour
372164	Professional shadow veil (refer to p. 32)		
	Ridge decoration (refer to p. 32)		
370133	Automatic window opener 'automapoly'		
DR	Extra roof window (when no ridge decoration)		
360120	Fold-away table (green)		
	Set of 2 shelves		

*The accessories must be ordered with the greenhouse (they are supplied with the greenhouse transport)*



## ACTION MODEL **R204L-B**



### SPECIFICATIONS

- Surface 6,91 m<sup>2</sup>
- Width 232 cm
- Length 298 cm
- Height of gutter 155 cm
- Height of ridge 211 cm
- 1 door + 1 roof window
- Door opening 161 x 68 cm

With 4 mm horticultural glass (art. R204L-B)

Aluminium frame  
Frame in RAL colour

With 4 mm safety glass (art. R204L-B plus)

Aluminium frame  
Frame in RAL colour

The greenhouse is delivered as a do-it-yourself pack. Clear instructions guide you throughout the easy assembly of this greenhouse, unless you have your greenhouse assembled by ACD.

- Options:**
- greenhouse assembly by ACD
  - assembly greenhouse accessories by ACD

### THE PACKAGE:

- FREE home delivery in a DIY kit**
- Roof in hammered glass**
- Self-supporting aluminium foundation with anchors**
- 12 year guarantee**
- Delivery term 3 weeks after order receipt,**
- 5 weeks in RAL colour, + 2 weeks assembly by ACD**

art.	description	in alu	in RAL colour
372141	Professional shadow veil (refer to p. 42)		
	Ridge decoration (refer to p. 42)		
HD	Screen door		
DR	Extra roof window		
	Universal working table 225 x 52 cm		
	Set of 2 shelves 86 x 15 cm		
370110	Automatic window opener 'automaluxe'		

*The accessories must be ordered with the greenhouse (they are supplied with the greenhouse transport)*



## ACTION MODEL **R305H-B**



### SPECIFICATIONS

- Surface 11,35 m<sup>2</sup>
- Width 306 cm
- Length 371 cm
- Height of gutter 179 cm
- Height of ridge 259 cm
- 1 door
- 1 roof window
- Door opening 185 x 68 cm

### THE PACKAGE:

- FREE home delivery in a DIY kit**
- Roof in hammered glass**
- Self-supporting aluminium foundation with anchors**
- 12 year guarantee**
- Delivery term 3 weeks after order receipt,**
- 5 weeks in RAL colour, + 2 weeks assembly by ACD**

With 4 mm horticultural glass (Art. R305H-B)

- Aluminium frame
- Frame in RAL colour

With 4 mm safety glass (Art. R305H-B plus)

- Aluminium frame
- Frame in RAL colour

The greenhouse is delivered as a do-it-yourself pack. Clear instructions guide you throughout the easy assembly of this greenhouse, unless you have your greenhouse assembled by ACD.

- Options:**
- greenhouse assembly by ACD
  - assembly of greenhouse accessories by ACD
  - greenhouse with increased height of 24 cm

art.	omschrijving	in alu	in RAL colour
372142	Professional shadow veil (refer to p. 42)		
	Ridge decoration (refer to p. 41)		
370110	Automatic window opener 'automaluxe'		
HD	Screen door		
DR	Extra roof window		
	Universal working table 225 x 52 cm		
	Set of 2 shelves 86 x 15 cm		

*The accessories must be ordered with the greenhouse (they are supplied with the greenhouse transport)*





## ACTION MODEL **R307H-B**



### SPECIFICATIONS

- Surface 15,88 m<sup>2</sup>
- Width 306 cm
- Length 519 cm
- Height of gutter 179 cm
- Height of ridge 259 cm
- 1 door
- 2 roof windows
- Door opening 185 x 68 cm

With 4 mm horticultural glass (Art. R307H-B)

Aluminium frame  
Frame in RAL colour

With 4 mm safety glass (Art. R307H-B plus)

Aluminium frame  
Frame in RAL colour

The greenhouse is delivered as a do-it-yourself pack. Clear instructions guide you throughout the easy assembly of this greenhouse, unless you have your greenhouse assembled by ACD.

- Options:**
- greenhouse assembly by ACD
  - assembly greenhouse accessories by ACD
  - greenhouse with increased height of 24 cm

### THE PACKAGE:

**FREE home delivery in a DIY kit**

**Roof in hammered glass**

**Self-supporting aluminium foundation with anchors**

**12 year guarantee**

**Delivery term 3 weeks after order receipt,**

**5 weeks in RAL colour, + 2 weeks assembly by ACD**

art.	description	in alu	in RAL colour
372143	Professional shadow veil (refer to p. 42)		
	Ridge decoration (refer to p. 41)		
370110	Automatic window opener 'automaluxe'		
HD	Screen door		
DR	Extra roof window		
	Universal working table 225 x 52 cm		
	Set of 2 shelves 86 x 15 cm		

*The accessories must be ordered with the greenhouse (they are supplied with the greenhouse transport)*

## The advantages of greenhouses with sloping walls

Greenhouses with sloping walls offer quite some advantages:

- less wind pressure
- a stable construction: better distribution of the roof weight
- more and better light and heat absorption

The latter advantage requires a word of explanation: glass allows through about 90 % of the total amount of light. Direct sun light must reach the roof in an angle of  $90^\circ$  in order to allow the maximal amount of light to pass. When the angle is greater or smaller, part of the light shall be reflected. In summertime most plants receive a sufficient amount of light. During spring and autumn there may be a shortage of light. A lot of research has been made to determine the best design for greenhouses. That is why greenhouses with sloping walls have been conceived. The best slope of the wall in relation to a horizontal surface is  $78^\circ$ . During winter the sunlight reaches the earth in an angle of about  $15^\circ$ . That means that the sloping walls of the greenhouse are more or less perpendicular to the sun rays and consequently allow a maximum amount of light to pass. During summertime the angle is less important, since the intensity of the sunlight is much higher. This means that a greenhouse with sloping walls simply extends your cultivation period.

Not only 'light' but also warmth, humidity and ventilation determine the climate in your greenhouse. They are the parameters for an optimal growth of your plants.

Enjoy your plant nursing!



## ACTION MODEL **S104H-B**



### SPECIFICATIONS

- Surface 9,12 m<sup>2</sup>
- Width 306 cm
- Length 298 cm
- Height of gutter 172 cm
- Height of ridge 237 cm
- 1 door + 1 roof window
- Door opening 185 x 68 cm

With 4 mm horticultural glass (Art. S104H-B)

Aluminium frame  
Frame in RAL colour

With 4 mm safety glass (Art. S104H-B plus)

Aluminium frame  
Frame in RAL colour

The greenhouse is delivered as a do-it-yourself pack. Clear instructions guide you throughout the easy assembly of this greenhouse, unless you have your greenhouse assembled by ACD.

- Options:**
- greenhouse assembly by ACD
  - assembly greenhouse accessories by ACD

### THE PACKAGE:

**FREE home delivery in a DIY kit**

**Roof in hammered glass**

**Self-supporting aluminium foundation with anchors**

**12 year guarantee**

**Delivery term 3 weeks after order receipt,**

**5 weeks in RAL colour, + 2 weeks assembly by ACD**

art.	description	in alu	in RAL colour
372144	Professional shadow veil (refer to p. 42)		
	Ridge decoration (refer to p. 41)		
HD	Screen door		
DR	Extra roof window		
	Universal working table 225 x 52 cm		
	Set of 2 shelves 86 x 15 cm		
370110	Automatic window opener 'automaluxe'		

*The accessories must be ordered with the greenhouse (they are supplied with the greenhouse transport)*



## ACTION MODEL **S106H-B**



ACTION MODELS

### SPECIFICATIONS

- Surface 13,62 m<sup>2</sup>
- Width 306 cm
- Length 445 cm
- Height of gutter 172 cm
- Height of ridge 237 cm
- 1 door
- 2 roof windows
- Door opening 185 x 68 cm

### THE PACKAGE:

- FREE home delivery in a DIY kit**
- Roof in hammered glass**
- Self-supporting aluminium foundation with anchors**
- 12 year guarantee**
- Delivery term 3 weeks after order receipt,**
- 5 weeks in RAL colour, + 2 weeks assembly by ACD**

With 4 mm horticultural glass (Art. S106H-B)

- Aluminium frame
- Frame in RAL colour

With 4 mm safety glass (Art. S106H-B plus)

- Aluminium frame
- Frame in RAL colour

The greenhouse is delivered as a do-it-yourself pack. Clear instructions guide you throughout the easy assembly of this greenhouse, unless you have your greenhouse assembled by ACD.

- Options:**
- greenhouse assembly by ACD
  - assembly greenhouse accessories by ACD

art.	description	in alu	in RAL colour
372145	Professional shadow veil (refer to p. 42)		
	Ridge decoration (refer to p. 41)		
370110	Automatic window opener 'automaluxe'		
HD	Screen door		
DR	Extra roof window		
	Universal working table 225 x 52 cm		
	Set of 2 shelves 86 x 15 cm		

*The accessories must be ordered with the greenhouse (they are supplied with the greenhouse transport)*



## ACTION MODEL **S208H-B**



### SPECIFICATIONS

- Surface 22,53 m<sup>2</sup>
- Width 380 cm
- Length 593 cm
- Height of gutter 172 cm
- Height of ridge 253 cm
- 1 door
- 4 roof windows
- Door opening 185 x 68 cm

### THE PACKAGE:

**FREE home delivery in a DIY kit**

**Roof in hammered glass**

**Self-supporting aluminium foundation with anchors  
12 year guarantee**

**Delivery term 3 weeks after order receipt,  
5 weeks in RAL colour, + 2 weeks assembly by ACD**

With 4 mm horticultural glass (Art. S208H-B)

Aluminium frame  
Frame in RAL colour

With 4 mm safety glass (Art. S208H-B plus)

Aluminium frame  
Frame in RAL colour

The greenhouse is delivered as a do-it-yourself pack. Clear instructions guide you throughout the easy assembly of this greenhouse, unless you have your greenhouse assembled by ACD.

- Options:**
- greenhouse assembly by ACD
  - assembly greenhouse accessories by ACD

art.	description	in alu	in RAL colour
372146	Professional shadow veil (refer to p. 32)		
	Ridge decoration (refer to p. 32)		
370110	Automatic window opener 'automaluxe'		
HD	Screen door		
DR	Extra roof window		
	Universal working table 225 x 52 cm		
	Set of 2 shelves 86 x 15 cm		

*The accessories must be ordered with the greenhouse (they are supplied with the greenhouse transport)*





## ACTION MODEL **R205H-RETRO**



### SPECIFICATIONS

- Surface 8,61 m<sup>2</sup>
- Width 232 cm
- Length 371 cm
- Height of gutter 179 cm
- Height of ridge 235 cm
- 1 door
- 1 roof window
- Door opening 185 x 68 cm

### Aluminium frame with black coating for a sustainable and elegant look

- Frame in RAL colour black
- Frame in different RAL colour

The greenhouse is delivered as a do-it-yourself pack. Clear instructions guide you throughout the easy assembly of this greenhouse, unless you have your greenhouse assembled by ACD.

- Options:**
- greenhouse assembly by ACD
  - assembly greenhouse accessories by ACD

### THE PACKAGE:

**Colour coating black RAL 9005**  
**Standard with 4 mm safety glass**

**FREE home delivery in a DIY kit**  
**Roof in hammered glass**

**Self-supporting aluminium foundation with anchors**  
**12 year guarantee**

**Delivery term 3 weeks after order receipt,**  
**5 weeks in RAL colour, + 2 weeks assembly by ACD**

art.	description		in RAL colour 9005
372150	Professional shadow veil (refer to p. 42) R205H-RETRO		
611015	Ridge decoration black (refer to p. 41)		
370110	Automatic window opener 'automaluxe'		
HD RETRO	Screen door black		
DV RETRO	Extra roof window black		
D-AK RETRO	Extra door on back wall black		
370173	Set of 2 shelves black 86 x 15 cm		
371012	Universal working table black 225 x 52 cm		

*The accessories must be ordered with the greenhouse (they are supplied with the greenhouse transport)*



## ACTION MODEL **R306H-RETRO**



### SPECIFICATIONS

- Surface 13,62 m<sup>2</sup>
- Width 306 cm
- Length 445 cm
- Height of gutter 179 cm
- Height of ridge 259 cm
- 1 door
- 2 roof windows
- Door opening 185 x 68 cm

### Aluminium frame with black coating for a sustainable and elegant look

- Frame in RAL colour black
- Frame in different RAL colour

The greenhouse is delivered as a do-it-yourself pack. Clear instructions guide you throughout the easy assembly of this greenhouse, unless you have your greenhouse assembled by ACD.

- Options:**
- greenhouse assembly by ACD
  - assembly greenhouse accessories by ACD

### THE PACKAGE:

- Colour coating black RAL 9005**
- Standard with 4 mm safety glass**
- FREE home delivery in a DIY kit**
- Roof in hammered glass**
- Self-supporting aluminium foundation with anchors**
- 12 year guarantee**
- Delivery term 3 weeks after order receipt, 5 weeks in RAL colour, + 2 weeks assembly by ACD**

art.	description		in RAL colour 9005
372152	Professional shadow veil (refer to p. 42) R306H-RETRO		
611016	Ridge decoration black (refer to p. 41)		
370110	Automatic window opener 'automaluxe'		
HD RETRO	Screen door black		
DV RETRO	Extra roof window black		
D-AK RETRO	Extra door on back wall black		
370173	Set of 2 shelves black 86 x 15 cm		
371012	Universal working table black 225 x 52 cm		

*The accessories must be ordered with the greenhouse (they are supplied with the greenhouse transport)*



## ACTION MODEL **R405H-RETRO**



### SPECIFICATIONS

- Surface 14,10 m<sup>2</sup>
- Width 380 cm
- Length 371 cm
- Height of gutter 179 cm
- Height of ridge 283 cm
- 1 door
- 2 roof windows
- Deuropening 185 x 68 cm

### Aluminium frame with black coating for a sustainable and elegant look

- Frame in RAL colour
- Frame in different RAL colour

The greenhouse is delivered as a do-it-yourself pack. Clear instructions guide you throughout the easy assembly of this greenhouse, unless you have your greenhouse assembled by ACD.

- Options:**
- greenhouse assembly by ACD
  - assembly greenhouse accessories by ACD

### THE PACKAGE:

- Colour coating black RAL 9005**
- Standard met 4 mm safety glass**
- FREE home delivery in a DIY kit**
- Roof in hammered glass**
- Self-supporting aluminium foundation with anchors**
- 12 year guarantee**
- Delivery term 3 weeks after order receipt,**
- 5 weeks in RAL colour, + 2 weeks assembly by ACD**

art.	description		in RAL colour 9005
372162	Professional shadow veil (refer to p. 42) R405H-RETRO		
611015	Ridge decoration black (refer to p. 41)		
370110	Automatic window opener 'automaluxe'		
HD RETRO	Screen door black		
EX-DO RETRO	Extra door for double door opening black		
DV RETRO	Extra roof window black		
D-AK RETRO	Extra door at back side black		
370173	Set of 2 shelves black 86 x 15 cm		
371012	Universal working table black 225 x 52 cm		

*The accessories must be ordered with the greenhouse (they are supplied with the greenhouse transport)*



## COMBO: grow and store all-in-one

R205H-COMBO



### SPECIFICATIONS

- Surface 8,61 m<sup>2</sup>
- Width 232 cm
- Length 371 cm
- Height of gutter 179 cm
- Height of ridge 235 cm
- 1 door
- 1 roof window
- 2 panes of storage room in black enamelled safety glass / 3 panes of greenhouse
- The storage room and the greenhouse are separated by an intermediate wall with door
- Delivery term: 3 to 4 weeks
- R205H-RETRO COMBO black
- R205H-RETRO COMBO full-option\*

### THE PACKAGE:

- Colour coating black RAL 9005**
- Standard with 4 mm safety glass**
- FREE home delivery in a DIY kit**
- Roof of greenhouse section in hammered glass**
- Self-supporting aluminium foundation with anchors**
- 12 year guarantee**
- Delivery term 3 weeks after order receipt,**
- + 2 weeks assembly by ACD**

The COMBO is delivered as a do-it-yourself pack. Clear instructions guide you throughout the easy assembly of this COMBO, unless you have your greenhouse assembled by ACD.

\*Full-option = including 1 door lock + 1 ventilation grid + 1 wooden floor (p. 43) with anti-root membrane, supporting structure and fixation material for storage + 2 shelves 225 x 32 cm + set of 2 shelves 86 x 15 cm - RAL 9005

- Options:**
- assembly R205H COMBO
  - assembly of greenhouse and accessories by ACD
  - assembly of wooden floor, length 2 panes

art.	description		in RAL colour 9005
372130	Professional shadow cloth - width 3,25 m – 3 panes - Combo R205-2		
611015	Ridge decoration black		
370110	Automatic window opener 'automaluxe'		
HD RETRO	Screen door black		
DV RETRO	Extra roof window black		
D-AK RETRO	Extra door on back wall black		
370173	Set of 2 shelves black 86 x 15 cm		
371012	Universal working table black 225 x 52 cm		
	Aluminium suspension system for shovels/rakes, black coated		
	Multifunctional suspension system in aluminium		
350905	Lock – coated greenhouse RAL 9005		
611905	Ventilation grid - RAL 9005		

*The accessories must be ordered with the greenhouse (they are supplied with the greenhouse transport)*

COMBO

## COMBO: grow and store all-in-one

**R305H-COMBO**



### SPECIFICATIONS

- Surface 11,35 m<sup>2</sup>
- Width 306 cm
- Length 371 cm
- Height of gutter 179 cm
- Height of ridge 259 cm
- 1 door
- 1 roof window
- Choice between: 2 or 3 panes of storage in black enamelled safety glass / 2 or 3 panes of greenhouse
- The storage room and the greenhouse are separated by an intermediate wall with door
- The COMBO is delivered as a do-it-yourself pack. Clear instructions guide you throughout the easy assembly of this COMBO, unless you have your greenhouse assembled by ACD.

### THE PACKAGE:

- Colour coating black RAL 9005**
- Standard with 4 mm safety glass**
- FREE home delivery in a DIY kit**
- Roof of the greenhouse section in hammered glass**
- Self-supporting aluminium foundation with anchors**
- 12 year guarantee**
- Delivery term 3 weeks after order receipt,**
- + 2 weeks assembly by ACD**

### **R305H COMBO with combination 2 storage / 3 greenhouse panes**

- R305H COMBO black / - R305H COMBO full-option\*

### **R305H COMBO with combination 3 storage / 2 greegnhouse panes**

- R305H COMBO black / - R305H COMBO full-option\*

\*Full-option = including 1 door lock + 2 ventilation grids + 1 wooden floor (p. 43) for storage with anti-root membrane, supporting structure and fixation material + 2 shelves 225 x 32 cm + set of 2 shelves 86 x 15 cm - RAL 9005

- Options:**
- assembly R305H COMBO / assembly of greenhouse and accessories by ACD
  - assembly of wooden floor, length 2 panes / length 3 panes

art.	description		in RAL colour 9005
372131	Professional shadow cloth - width 4,30 m - Combo R305-2		
372132	Professional shadow cloth - width 4,30 m - Combo R305-3		
611015	Ridge decoration black		
370110	Automatic window opener 'automaluxe'		
HD RETRO	Screen door black		
DV RETRO	Extra roof window black		
D-AK RETRO	Extra door on back wall black		
370173	Set of 2 shelves black 86 x 15 cm		
371012	Universal working table black 225 x 52 cm		
	Aluminium suspension system for shovels/rakes, black coated		
	Multifunctional suspension system in aluminium		
350905	Lock – coated greenhouse RAL 9005		
611905	Ventilation grid - RAL 9005		

*The accessories must be ordered with the greenhouse (they are supplied with the greenhouse transport)*



## COMBO: grow and store all-in-one

R306H-COMBO



### SPECIFICATIONS

- Surface 13,62 m<sup>2</sup>
- Width 306 cm
- Length 445 cm
- Height of gutter 179 cm
- Height of ridge 259 cm
- 1 door + 2 roof windows
- Choice between: 2 or 3 panes of storage in black enamelled safety glass / 4 greenhouse panes or 3 storage panes in black enamelled safety glass / 3 greenhouse panes
- The storage room and the greenhouse are separated by an intermediate wall with door
- The COMBO is delivered as a do-it-yourself pack. Clear instructions guide you throughout the easy assembly of this COMBO, unless you have your greenhouse assembled by ACD.

### THE PACKAGE:

- Colour coating black RAL 9005**
- Standard with 4 mm safety glass**
- FREE home delivery in a DIY kit**
- Roof of the greenhouse section in hammered glass**
- Self-supporting aluminium foundation with anchors**
- 12 year guarantee**
- Delivery term 3 weeks after order receipt, + 2 weeks assembly by ACD**

### R306H COMBO with combination 2 storage / 4 greenhouse panes

- R306H COMBO black / - R306H COMBO full-option\*

### R306H COMBO with combination 3 storage / 3 greenhouse panes

- R306H COMBO black / - R306H COMBO full-option\*

\*Full-option = including 1 door lock + 2 ventilation grids + 1 wooden floor (p. 43) for storage with anti-root membrane, supporting structure and fixation material + 2 shelves 225 x 32 cm + set of 2 shelves 86 x 15 cm - RAL 9005

- Options:**
- assembly R306H COMBO / assembly of greenhouse and accessories by ACD
  - assembly of wooden floor, length 2 panes / length 3 panes

art.	description		in RAL colour 9005
372133	Professional shadow cloth - width 4,30 m - Combo R306-2		
372134	Professional shadow cloth - width 4,30 m - Combo R306-3		
611016	Ridge decoration black		
370110	Automatic window opener 'automaluxe'		
HD RETRO	Screen door black		
DV RETRO	Extra roof window black		
D-AK RETRO	Extra door on back wall black		
370173	Set of 2 shelves black 86 x 15 cm		
371012	Universal working table black 225 x 52 cm		
	Aluminium suspension system for shovels/rakes, black coated		
	Multifunctional suspension system in aluminium		
350905	Lock – coated greenhouse RAL 9005		
611905	Ventilation grid - RAL 9005		

The accessories must be ordered with the greenhouse (they are supplied with the greenhouse transport)

## COMBO: grow and store all-in-one

## R307H-COMBO



### SPECIFICATIONS

- Surface 15,88 m<sup>2</sup>
- Width 306 cm
- Length 519 cm
- Height of gutter 179 cm
- Height of ridge 259 cm
- 1 door + 2 roof windows
- Choice between: 2 storage panes in black enamelled safety glass / 5 greenhouse panes or 3 storage panes in black enamelled safety glass / 4 greenhouse panes
- The storage room and the greenhouse are separated by an intermediate wall with door
- The COMBO is delivered as a do-it-yourself pack. Clear instructions guide you throughout the easy assembly of this COMBO, unless you have your greenhouse assembled by ACD.

### THE PACKAGE:

**Colour coating black RAL 9005**  
**Standard with 4 mm safety glass**  
**FREE home delivery in a DIY kit**  
**Roof of the greenhouse section in hammered glass**  
**Self-supporting aluminium foundation with anchors**  
**12 year guarantee**  
**Delivery term 3 weeks after order receipt,**  
**+ 2 weeks assembly by ACD**

### **R307H COMBO with combination 2 storage / 5 greenhouse panes**

- R307H COMBO black / - R307H COMBO full-option\*

### **R307H COMBO with combination 3 storage / 4 greenhouse panes**

- R307H COMBO black / - R307H COMBO full-option\*

\*Full-option = including 1 door lock + 2 ventilation grids + 1 wooden floor (p. 43) for storage with anti-root membrane, supporting structure and fixation material + 2 shelves 225 x 32 cm + set of 2 shelves 86 x 15 cm - RAL 9005

- Options:**
- assembly R307H COMBO / assembly of greenhouse and accessories by ACD
  - assembly of wooden floor, length 2 panes / length 3 panes

art.	description		in RAL colour 9005
372135	Professional shadow cloth - width 4,30 m - Combo R307-2		
372136	Professional shadow cloth - width 4,30 m - Combo R307-3		
611017	Ridge decoration black		
370110	Automatic window opener 'automaluxe'		
HD RETRO	Screen door black		
DV RETRO	Extra roof window black		
D-AK RETRO	Extra door on back wall black		
370173	Set of 2 shelves black 86 x 15 cm		
371012	Universal working table black 225 x 52 cm		
	Aluminium suspension system for shovels/rakes, black coated		
	Multifunctional suspension system in aluminium		
350905	Lock – coated greenhouse RAL 9005		
611905	Ventilation grid - RAL 9005		

The accessories must be ordered with the greenhouse (they are supplied with the greenhouse transport)



### Combo storage possibilities



**NEW**

## GARDEN ROOMS

---

*'The beating heart of the garden'*



*Model on photograph: La serre de Babette*

## LA SERRE D'AURÉLIE



### SPECIFICATIONS

- Surface 10,26 m<sup>2</sup>
- Width 303 cm
- Length 371 cm
- Height of gutter 179 cm
- Height of ridge 235 cm
- 1 door
- 2 roof windows - optional (max. 1 extra)
- Glass surface 31,67 m<sup>2</sup>
- La serre d'Aurélié

### THE PACKAGE:

- Colour coating black RAL 9005**
- Standard with 4 mm safety glass**
- FREE home delivery in a DIY kit**
- Roof in clear glass**
- Self-supporting aluminium foundation with anchors**
- 12 year guarantee**
- Delivery term 5 weeks after order receipt,**
- + 2 weeks assembly by ACD**



The garden room is delivered as a do-it-yourself pack.

Clear instructions guide you throughout the easy assembly of this garden room.

### Options:

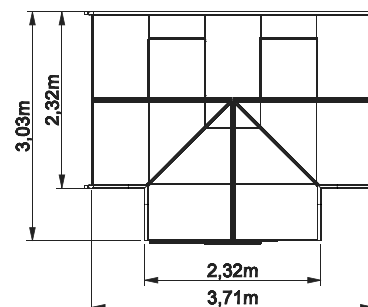
- frame in different RAL colour
- assembly serre d'Aurélié
- assembly of accessories by ACD
- assembly of wooden floor Aurélié



art.	description		in RAL colour 9005
611090	Ridge decoration black Aurélié		
370110	Automatic window opener 'automaluxe'		
HD RETRO	Ventilation door with black mesh		
DV RETRO	Extra roof window black		
370173	Set of 2 shelves black 86 x 15 cm		
371014	Shelve with inlay 225 x 32 cm black		
382020	Wooden floor with anti-root membrane + fixation kit		
350905	Door lock coated greenhouse RAL 9005		
	Extra door in side wall black		
	Extra door on back wall black		
	Double door on back wall black		
	Double door in front wall is not available for this type.		

The accessories must be ordered with the greenhouse (they are supplied with the greenhouse transport)

## LA SERRE DE BABETTE



### SPECIFICATIONS

- Surface 15,40 m<sup>2</sup>
- Width 377 cm
- Length 519 cm
- Height of gutter 179 cm
- Height of ridge 235 cm
- 1 door
- 2 roof windows - optional (max. 1 extra)
- Glass surface 45,32 m<sup>2</sup>
- La serre de Babette

The garden room is delivered as a do-it-yourself pack. Clear instructions guide you throughout the easy assembly of this garden room.



### Options:

- frame in different RAL colour
- assembly serre de Babette
- assembly of accessories by ACD
- assembly of wooden floor Babette

### THE PACKAGE:

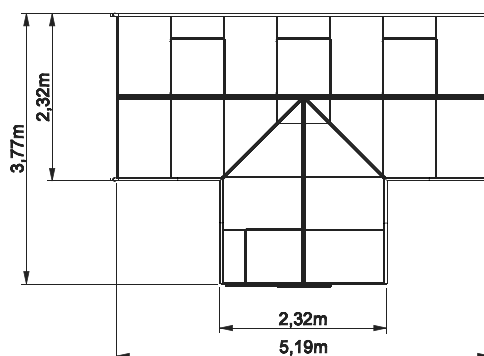
**Colour coating black RAL 9005**  
**Standard with 4 mm safety glass**  
**FREE home delivery in a DIY kit**  
**Roof in clear glass**  
**Self-supporting aluminium foundation with anchors**  
**12 year guarantee**  
**Delivery term 5 weeks after order receipt,**  
**+ 2 weeks assembly by ACD**



art.	description		in RAL colour 9005
611091	Ridge decoration black Babette		
370110	Automatic window opener 'automaluxe'		
HD RETRO	Ventilation door with black mesh		
DV RETRO	Extra roof window black		
370173	Set of 2 shelves black 86 x 15 cm		
371014	Shelve with inlay 225 x 32 cm black		
382021	Wooden floor with anti-root membrane + fixation kit		
350905	Door lock coated greenhouse RAL 9005		
	Extra door in side wall black		
	Extra door on back wall black		
	Double door on back wall black		
	Double door in front wall is not available for this type.		

*The accessories must be ordered with the greenhouse (they are supplied with the greenhouse transport)*

## LA SERRE D'HÉLÈNE



### SPECIFICATIONS

- Surface 15,79 m<sup>2</sup>
- Width 377 cm
- Length 445 cm
- Height of gutter 179 cm
- Height of ridge 259 cm
- 1 door
- 2 roof windows - optional (max. 1 extra)
- Glass surface 41,44 m<sup>2</sup>
- La serre d'Hélène

### THE PACKAGE:

**Colour coating black RAL 9005**  
**Standard with 4 mm safety glass**  
**FREE home delivery in a DIY kit**  
**Roof in clear glass**  
**Self-supporting aluminium foundation with anchors**  
**12 year guarantee**  
**Delivery term 5 weeks after order receipt,**  
**+ 2 weeks assembly by ACD**



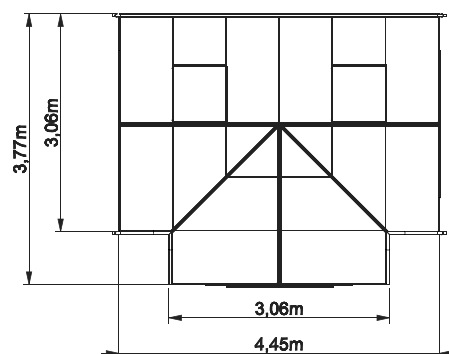

The garden room is delivered as a do-it-yourself pack.  
 Clear instructions guide you throughout the easy assembly of this garden room.

### Options:

- frame in different RAL colour
- assembly serre d'Hélène
- assembly of accessories by ACD
- assembly of wooden floor Hélène



GARDEN ROOMS

art.	description		in RAL colour 9005
611092	Ridge decoration black Hélène		
370110	Automatic window opener 'automaluxe'		
HD RETRO	Ventilation door with black mesh		
DV RETRO	Extra roof window black		
370173	Set of 2 shelves black 86 x 15 cm		
371014	Shelve with inlay 225 x 32 cm black		
382023	Wooden floor with anti-root membrane + fixation kit		
350905	Door lock coated greenhouse RAL 9005		
	Extra door in side wall black		
	Extra door on back wall black		
	Double door on back wall black		
	Double door in front wall is not available for this type.		

The accessories must be ordered with the greenhouse (they are supplied with the greenhouse transport)

## LA SERRE DE SOPHIE



### SPECIFICATIONS

- Surface 22,59 m<sup>2</sup>
- Width 377 cm
- Length 519 cm
- Height of gutter 179 cm
- Height of ridge 259 cm
- 1 door
- 5 roof windows - optional (max. 2 extra), in case of decorative ridge a maximum is 5 panes is allowed
- Glass surface 55,90 m<sup>2</sup>
- La serre de Sophie

The garden room is delivered as a do-it-yourself pack. Clear instructions guide you throughout the easy assembly of this garden room.





### Options:

- frame in different RAL colour
- assembly serre de Sophie
- assembly of accessories by ACD
- assembly of wooden floor Sophie

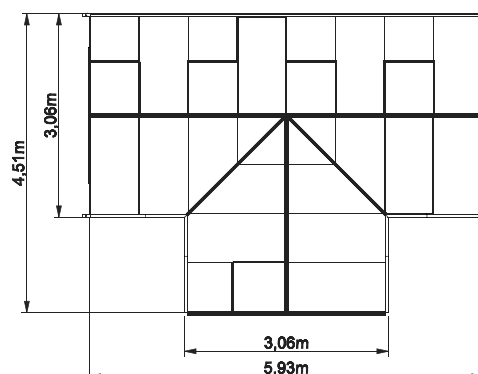
### THE PACKAGE:

**Colour coating black RAL 9005**  
**Standard with 4 mm safety glass**  
**FREE home delivery in a DIY kit**  
**Roof in clear glass**  
**Self-supporting aluminium foundation with anchors**  
**12 year guarantee**  
**Delivery term 5 weeks after order receipt,**  
**+ 2 weeks assembly by ACD**



art.	description		in RAL colour 9005
611093	Ridge decoration black Sophie		
370110	Automatic window opener 'automaluxe'		
HD RETRO	Ventilation door with black mesh		
DV RETRO	Extra roof window black		
370173	Set of 2 shelves black 86 x 15 cm		
371014	Shelve with inlay 225 x 32 cm black		
382022	Wooden floor with anti-root membrane + fixation kit		
350905	Door lock coated greenhouse RAL 9005		
	Extra door in side wall black		
	Extra door for double door opening in front and back walls		
	Double door in back wall black		
	Double door in back wall black (2 doors)		

*The accessories must be ordered with the greenhouse (they are supplied with the greenhouse transport)*



## LIST OF ALL OPTIONS

The ACD® PRESTIGE comes standard with one single door in the front wall. Below please find the prices charged for adapting the standard equipment. These options must be mentioned in the greenhouse order form in order to be shipped with the greenhouse free of charge. For the assembly of the accessories combined with the assembly of the greenhouse, a fee of € 50 is charged (without assembly of the wooden floor → page 43). For separate or late orders of accessories, please refer to your local reseller for information about the extra costs.

### Extras for the front and back walls:



- **Extra door in the back wall:**  
/ coated
- **Extra door in the front wall or the back wall for double door opening:**  
/ coated
  - o Only available with R3, R4, S2, S3 en MS3
    - Door opening with R3, R4, S2, S3: 185 x 139 cm
    - Door opening with MS3: 179 x 139 cm

### Extras for the side wall:

The first adaptation of the side wall results in a small extra charge in order to adapt the gutter profile at the point of fixation of the sliding door. These adaptations are only available in greenhouses **with straight walls** (R1, R2, R3, R4, MR2, MR3). For safety glass, the term of delivery is min. 5 weeks.



- **Door in the side wall**  
Adapted profile on the side wall + door: / coated
- **Double door in the side wall (2 doors)**  
/ coated



**Screen door (meshed door)** keeps cats, dogs, rabbits, birds ... out of your greenhouse and allows a perfect ventilation. Not available in combination with a double door. Not available with PRESTIGE PICCOLO.

/ coated

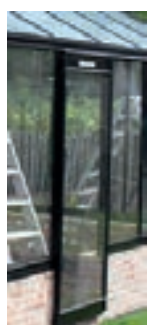

If your greenhouse is wall mounted, you need an extended door and/or screen door (extension max 0,50 m)

- Extended door ACD P for front/back wall: / coated
- Extended door ACD P for side wall: / coated
- Extra door for double door opening in extended wall: / coated
- Double door extended for side wall (2 doors): / coated
- Extended screen door (front/back and side wall) is not available in combination with a double door: / coated

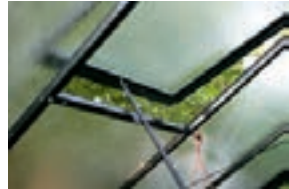

art. DR  
**extra roof window**  
/ coated



**aluminium shelf 150 cm x 13 cm**  
/ coated



**set of 2 aluminium shelves 86 x 15 cm**  
/ coated



**set of 2 aluminium shelf brackets**  
/ coated



**shelf with inlay 225 cm x 32 cm**  
/ coated



**sowing table with raised edge 217 cm x 42 cm**  
/ coated



**universal working table 225 cm x 52 cm**  
/ coated



Small and practical suspension system for heaters, shadow veils etc., ...

art. 681940

**L-profile aluminium 3 x 3 x H 3 cm**, per 10 items

art. 681945

**L-profile black 3 x 3 x H 3 cm**, per 10 items



art. 373284

**extra bolt in stainless steel M6 x 10, nut included**,  
per 25 items



art. 373283  
**tee bolt in stainless steel, nut included,**  
 per 18 items



art. 373282  
**tomato hook in stainless steel, incl. 2 small nuts,**  
 per 10 items



ideal pour suspending items  
 art. 373288  
**V-clip mounting clip,**  
 per 20 items



for fixing shadow veils, bubble wrap, etc.  
 art. 373281  
**fix-clip,**  
 per 50 items



for fixing shadow veils, bubble wrap, etc.  
 art. 373287  
**snap shot,**  
 per 25 items



**Ridge decoration**



	ALU	/	RAL colour
length 3 panes		/	coated
length 4 panes		/	coated
length 5 panes		/	coated
length 6 panes		/	coated
length 7 panes		/	coated
length 8 panes		/	coated
length 9 panes		/	coated
length 10 panes		/	coated



art. 370110  
**'Automaluxe'** frame in stainless steel



art. 370133 '  
**'Automapoly'** with 2 draw springs



art. 530241  
**200 L rain butt green**, diam. 65 x H 87 cm  
 (incl. lid and tap, with base free of charge)

art. 525905  
**210 L rain butt black**, diam. 77 x H 80 cm  
 (incl. lid and tap, with base free of charge)

art. 520200  
**Rain butt tap**



**Ventilation grid**  
 Alu  
 Coated

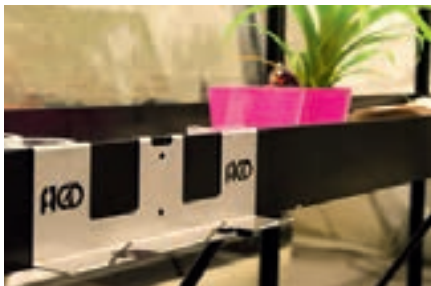

**Multifunctional suspension system**  
 Aluminium  
 Coated

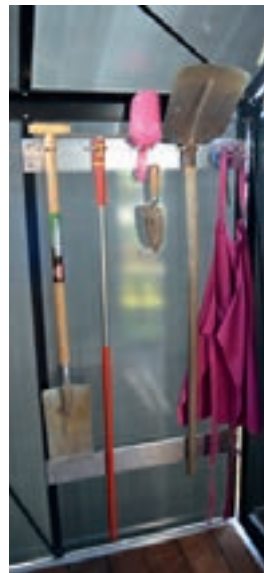

**Suspension system for shovels/rakes**  
 Aluminium  
 Coated



**Door lock**  
 Aluminium  
 Coated

**Professional shadow veils**

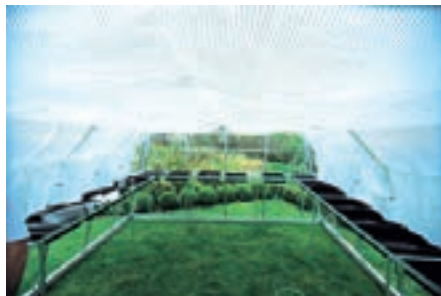

Width 3,25 m of 4,30 m / length as wanted

Fabric of translucent and aluminium sheeting.

Excessive sun radiation during spring and summer time can easily heat up the greenhouse, causing plants to dy. A good protection is important for more than just one reason: prevent overheated atmosphere in the greenhouse, protect plants against burn and decolouration, prevent dehydration of plants etc.

## WOODEN FLOORS

Wooden floors are an extra option for our greenhouses (delivery term of 5 weeks).

These floors add value to your greenhouse, giving them an extra dimension. They even allow you to turn your greenhouse in a garden room.

Enjoy a good book with a cup of tea in the greenhouse with a wooden floor. And when the fall has come, it is great to spend some time in the cosy warmth behind the glass of your greenhouse.

The floor in hard wood is easy to clean and gives your greenhouse a warm, cosy and homelike comfort.

Refer to your local reseller for more information.

### How to use the table:

STEP 1: take the width of your greenhouse

STEP 2: choose the length of the floor



Cut to measure:

including: - anti-root membrane  
- alu frame underground fixation material

Wooden floor for	Floor length	Number of panes in the length	Price*	Assembly
<b>Piccolo</b>	2,24 m	3		
<b>Greenhouse width</b>				
<b>R1-R2 2,02 of 2,32 m</b>	1,51 m	2		
	2,24 m	3		
	2,98 m	4		
	3,71 m	5		
	4,45 m	6		
	5,19 m	7		
	5,93 m	8		
	6,67 m	9		
	7,41 m	10		
<b>R3-S1 3,06 m</b>	1,51 m	2		
	2,24 m	3		
	2,98 m	4		
	3,71 m	5		
	4,45 m	6		
	5,19 m	7		
	5,93 m	8		
	6,67 m	9		
	7,41 m	10		
<b>S2-R4 3,80 m</b>	1,51 m	2		
	2,24 m	3		
	2,98 m	4		
	3,71 m	5		
	4,45 m	6		
	5,19 m	7		
	5,93 m	8		
	6,67 m	9		
	7,41 m	10		
<b>S3 4,53 m</b>	1,51 m	2		
	2,24 m	3		
	2,98 m	4		
	3,71 m	5		
	4,45 m	6		
	5,19 m	7		
	5,93 m	8		
	6,67 m	9		
	7,41 m	10		
<b>GARDEN ROOMS</b>				
<b>Aurélie</b>				
<b>Babette</b>				
<b>Hélène</b>				
<b>Sophie</b>				



# ALL MODELS ACD® PRESTIGE

## GREENHOUSE WITH STRAIGHT WALLS

**WIDTH 2,02 M - R1H  
HIGH MODEL**

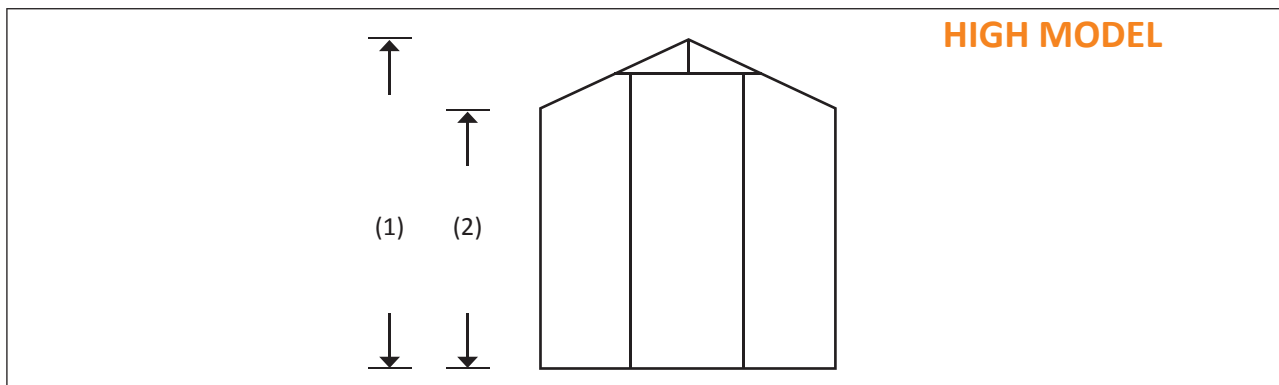

- 1 front sliding door, width 0,68 m x height 1,85 m
- number of roof windows (0,78 m x 0,73 m) according to the length of your greenhouse (see table)
- standard hammered glass in the roof
- choice between 4 mm horticultural glass and 4 mm safety glass (EU-standard EN12150)
- rubber strips contribute to an airtight and watertight assembly
- self-supporting aluminium foundation included = no concrete foundation required
- ground anchors included
- free home delivery
- 12 year manufacturer's guarantee
- each greenhouse can be delivered in the RAL colour you choose
- do-it-yourself building pack or (optional) assembly by ACD
- term of delivery: 5 weeks in horticultural glass / 10 weeks in safety glass / + 2 weeks in RAL colour, + 2 weeks assembly by ACD.

Width 2,02 m	R103H	R104H	R105H	R106H	R107H	R108H	R109H	R110H
--------------	-------	-------	-------	-------	-------	-------	-------	-------

length	2.24 m	2.98 m	3.71 m	4.45 m	5.19 m	5.93 m	6.67 m	7.41 m
height of ridge (1)	2,20 m	2,20 m	2,20 m	2,20 m	2,20 m	2,20 m	2,24 m	2,24 m
height of gutter (2)	1,79 m	1,79 m	1,79 m	1,79 m	1,79 m	1,79 m	1,83 m	1,83 m
# roof windows	1	1	1	2	2	4	4	6
ground surface m <sup>2</sup>	4,52	6,02	7,49	8,99	10,48	11,98	13,47	14,97
glass surface m <sup>2</sup>	19,0	22,6	26,2	29,8	33,4	36,9	40,5	44,1

aluminium								
RAL colour								

assembly								
assembly accessories*								

\*During greenhouse assembly

# GREENHOUSE WITH STRAIGHT WALLS

WIDTH 2,32 M - R2L

LOW MODEL

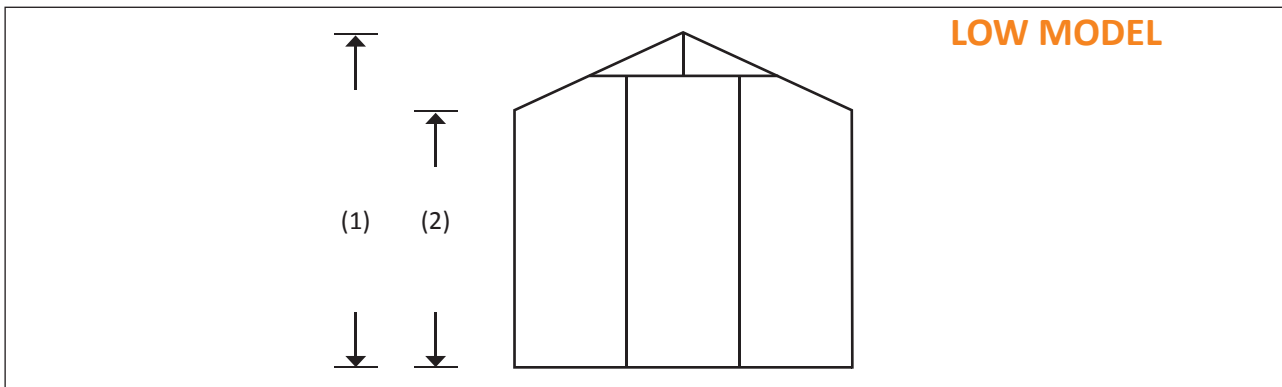

- 1 front sliding door, width 0,68 m x height 1,61 m
- number of roof windows (0,78 m x 0,73 m) according to the length of your greenhouse (see table)
- standard hammered glass in the roof
- choice between 4 mm horticultural glass and 4 mm safety glass (EU-standard EN12150)
- rubber strips contribute to an airtight and watertight assembly
- self-supporting aluminium foundation = no concrete foundation required
- ground anchors included
- free home delivery
- 12 year manufacturer's guarantee
- each greenhouse can be delivered in the RAL colour you choose
- do-it-yourself building pack or (optional) assembly by ACD
- term of delivery 5 weeks both for horticultural glass and safety glass + 2 weeks in RAL colour
- in this size we offer you the **action model R204L** (refer to p. 11): 2,32 m x 2,98 m  
with as extra benefits:
  - o lower price
  - o delivery term 3 weeks + 2 weeks in RAL colour, + 2 weeks assembly by ACD

Width 2,32 m	R203L	<b>R204L</b>	R205L	R206L	R207L	R208L	R209L	R210L
--------------	-------	--------------	-------	-------	-------	-------	-------	-------

length	2.24 m	2.98 m	3.71 m	4.45 m	5.19 m	5.93 m	6.67 m	7.41 m
height of ridge (1)	2,11 m	2,11 m	2,11 m	2,11 m	2,11 m	2,11 m	2,15 m	2,15 m
height of gutter (2)	1,55 m	1,55 m	1,55 m	1,55 m	1,55 m	1,55 m	1,59 m	1,59 m
# roof windows	1	1	1	2	2	4	4	6
ground surface m <sup>2</sup>	5,20	6,91	8,61	10,32	12,04	13,76	15,47	17,19
glass surface m <sup>2</sup>	18,8	22,6	26,4	30,2	34,1	37,9	41,7	45,5

aluminium								
RAL colour								

assembly								
assembly accessories*								

\*During greenhouse assembly



## GREENHOUSE WITH STRAIGHT WALLS

WIDTH 2,32 M - R2H  
HIGH MODEL

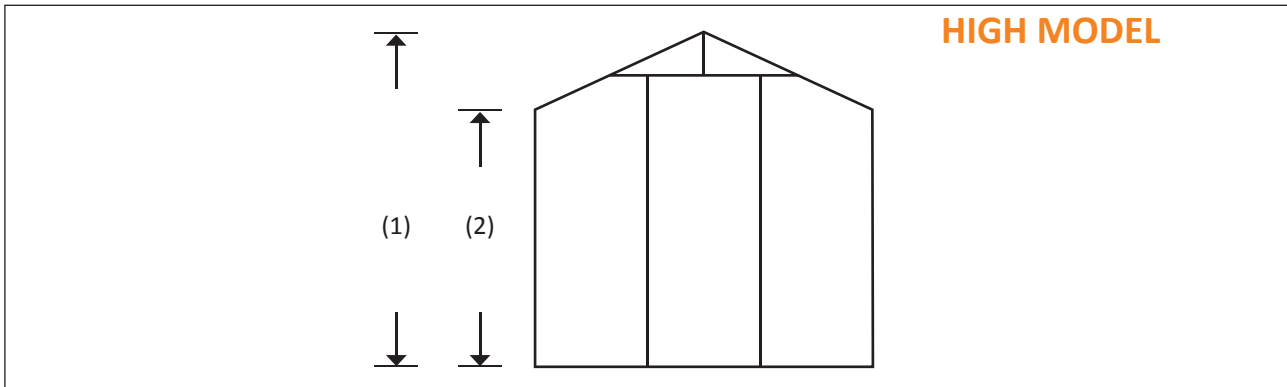

- 1 front sliding door, width 0,68 m x height 1,85 m
- number of roof windows (0,78 m x 0,73 m) according to the length of your greenhouse (see table)
- standard hammered glass in the roof
- choice between 4 mm horticultural glass and 4 mm safety glass (EU-standard EN12150)
- rubber strips contribute to an airtight and watertight assembly
- self-supporting aluminium foundation included = no concrete foundation required
- ground anchors included
- free home delivery
- 12 year manufacturer's guarantee
- each greenhouse can be delivered in the RAL colour you choose
- do-it-yourself building pack or (optional) assembly by ACD
- term of delivery: 5 weeks in horticultural glass and safety glass + 2 weeks in RAL colour, + 2 weeks assembly by ACD.
- in this size we offer you the **action model R205H-RETRO** (refer to p. 23): 2,32 m x 3,71 m with as extra benefits:
  - o lower price
  - o delivery term 3 weeks + 2 weeks in RAL colour, + 2 weeks assembly by ACD

Width 2,32 m	R203H	R204H	R205H	R206H	R207H	R208H	R209H	R210H
--------------	-------	-------	-------	-------	-------	-------	-------	-------

length	2.24 m	2.98 m	3.71 m	4.45 m	5.19 m	5.93 m	6.67 m	7.41 m
height of ridge (1)	2,35 m	2,35 m	2,35 m	2,35 m	2,35 m	2,35 m	2,39 m	2,39 m
height of gutter (2)	1,79 m	1,79 m	1,79 m	1,79 m	1,79 m	1,79 m	1,83 m	1,83 m
# roof windows	1	1	1	2	2	4	4	6
ground surface m <sup>2</sup>	5,20	6,91	8,61	10,32	12,04	13,76	15,47	17,19
glass surface m <sup>2</sup>	20,9	25,1	29,2	33,1	37,6	41,7	45,9	50,1

aluminium								
RAL colour								

assembly								
assembly accessories*								

\*During greenhouse assembly



## GREENHOUSE WITH STRAIGHT WALLS

WIDTH 3,06 M - R3L

LOW MODEL

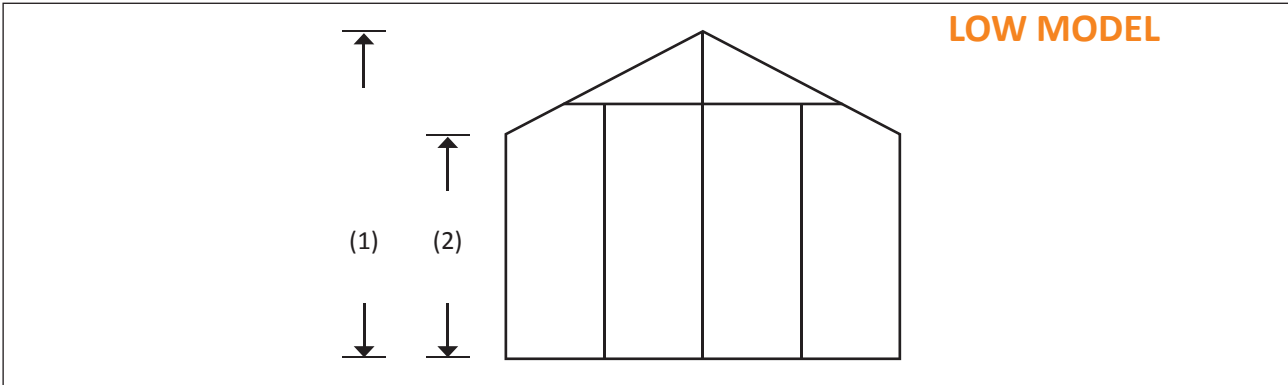

- 1 front sliding door, width 0,68 m x height 1,61 m
- number of roof windows (0,78 m x 0,73 m) according to the length of your greenhouse (see table)
- standard hammered glass in the roof
- choice between 4 mm horticultural glass and 4 mm safety glass (EU-standard EN12150)
- rubber strips contribute to an airtight and watertight assembly
- self-supporting aluminium foundation = no concrete foundation required
- ground anchors included
- free home delivery
- 12 year manufacturer's guarantee
- each greenhouse can be delivered in the RAL colour you choose
- do-it-yourself building pack or (optional) assembly by ACD
- term of delivery 5 weeks in horticultural glass / 10 weeks in safety glass / + 2 weeks in RAL colour, + 2 weeks assembly by ACD.

Width 3,06 m	R303L	R304L	R305L	R306L	R307L	R308L	R309L	R310L
--------------	-------	-------	-------	-------	-------	-------	-------	-------

length	2.24 m	2.98 m	3.71 m	4.45 m	5.19 m	5.93 m	6.67 m	7.41 m
height of ridge (1)	2,35 m	2,35 m	2,35 m	2,35 m	2,35 m	2,35 m	2,39 m	2,39 m
height of gutter (2)	1,55 m	1,55 m	1,55 m	1,55 m	1,55 m	1,55 m	1,59 m	1,59 m
# roof windows	1	1	1	2	2	4	4	6
ground surface m <sup>2</sup>	6,85	9,12	11,35	13,62	15,88	18,15	20,41	22,68
glass surface m <sup>2</sup>	23,9	28,4	32,9	37,3	41,8	46,2	50,7	55,2

aluminium								
RAL colour								

assembly								
assembly accessories*								

\*During greenhouse assembly

## GREENHOUSE WITH STRAIGHT WALLS

**WIDTH 3,06 M - R3H  
HIGH MODEL**

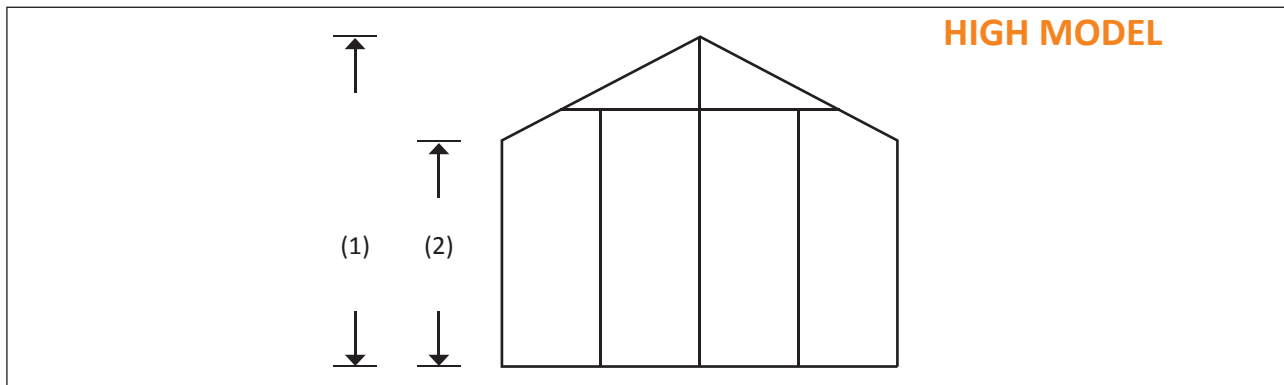

- 1 front sliding door, width 0,68 m x height 1,85 m
  - number of roof windows (0,78 m x 0,73 m) according to the length of your greenhouse (see table)
  - standard hammered glass in the roof
  - choice between 4 mm horticultural glass and 4 mm safety glass (EU-standard EN12150)
  - rubber strips contribute to an airtight and watertight assembly
  - self-supporting aluminium foundation = no concrete foundation required
  - ground anchors included
  - free home delivery
  - 12 year manufacturer's guarantee
  - each greenhouse can be delivered in the RAL colour you choose
  - do-it-yourself building pack or (optional) assembly by ACD
  - term of delivery 5 weeks horticultural glass en safety glass + 2 weeks in RAL colour, + 2 weeks assembly by ACD.
  - in this size we offer you **3 action models**:
    - o action model R305H (refer to p. 13): 3,06 m x 3,71 m
    - o action model R307H (refer to p. 15): 3,06 m x 5,19 m
- with as extra benefits:**
- o lower price
  - o delivery term 3 weeks + 2 weeks in RAL colour
  - o action model R306H-RETRO (refer to p. 27): 3,06 m x 4,46 m

Width 3,06 m	R303H	R304H	R305H	R306H	R307H	R308H	R309H	R310H
--------------	-------	-------	-------	-------	-------	-------	-------	-------

length	2.24 m	2.98 m	3.71 m	4.45 m	5.19 m	5.93 m	6.67 m	7.41 m
height of ridge (1)	2,59 m	2,59 m	2,59 m	2,59 m	2,59	2,59 m	2,63 m	2,63 m
height of gutter (2)	1,79 m	1,79 m	1,79 m	1,79 m	1,79	1,79 m	1,83 m	1,83 m
# roof windows	1	1	1	2	2	4	4	6
ground surface m <sup>2</sup>	6,85	9,12	11,35	13,62	15,88	18,15	20,41	22,68
glass surface m <sup>2</sup>	26,4	31,2	36,0	40,8	45,7	50,5	55,3	60,1

aluminium								
RAL colour								

assembly								
assembly accessories*								

\*During greenhouse assembly

## GREENHOUSE WITH STRAIGHT WALLS

WIDTH 3,80 M - R4H

HIGH MODEL

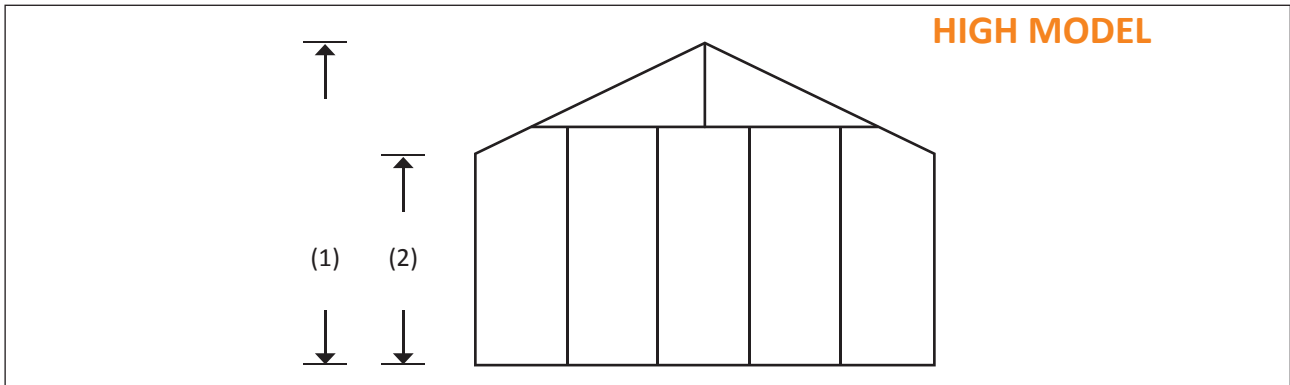

- 1 front sliding door, width 0,68 m x height 1,85 m
- number of roof windows (0,78 m x 0,73 m) according to the length of your greenhouse (see table)
- standard hammered glass in the roof
- choice between 4 mm horticultural glass and 4 mm safety glass (EU-standard EN12150)
- rubber strips contribute to an airtight and watertight assembly
- self-supporting aluminium foundation = no concrete foundation required
- ground anchors included
- free home delivery
- 12 year manufacturer's guarantee
- each greenhouse can be delivered in the RAL colour you choose
- do-it-yourself building pack or (optional) assembly by ACD
- term of delivery 5 weeks in horticultural glass / 10 weeks in safety glass / + 2 weeks in RAL colour, + 2 weeks assembly by ACD.
- in this size we offer you the **action model R405H-RETRO** (refer to p. 27): 3,80 m x 3,71 m with as extra benefits:
  - o lower price
  - o delivery term 3 weeks + 2 weeks in RAL colour, + 2 weeks assembly by ACD

Width 3,80 m	R403H	R404H	R405H	R406H	R407H	R408H	R409H	R410H
--------------	-------	-------	-------	-------	-------	-------	-------	-------

length	2.24 m	2.98 m	3.71 m	4.45 m	5.19 m	5.93 m	6.67 m	7.41 m
height of ridge (1)	2,83 m	2,83 m	2,83 m	2,83	2,83 m	2,83 m	2,83 m	2,83 m
height of gutter (2)	1,83 m	1,83 m	1,83 m	1,83	1,83 m	1,83 m	1,83 m	1,83 m
# roof windows	1	2	2	3	4	5	6	7
ground surface m <sup>2</sup>	8,51	11,32	14,10	16,91	19,72	22,53	25,35	28,16
glass surface m <sup>2</sup>	30,54	35,94	41,34	46,74	52,14	57,54	62,94	68,34

aluminium								
RAL colour								

assembly								
assembly accessories*								

\*During greenhouse assembly



## GREENHOUSE WITH SLOPING WALLS

**WIDTH 3,06 M - S1  
HIGH MODEL**



- advantages of sloping walls: refer to p. 16
- 1 front sliding door, width 0,68 m x height 1,85 m
- number of roof windows (0,78 m x 0,73 m) according to the length of your greenhouse (see table)
- standard hammered glass in the roof
- choice between 4 mm horticultural glass and 4 mm safety glass (EU-standard EN12150)
- rubber strips contribute to an airtight and watertight assembly
- self-supporting aluminium foundation = no concrete foundation required
- ground anchors included
- free home delivery
- 12 year manufacturer's guarantee
- each greenhouse can be delivered in the RAL colour you choose
- do-it-yourself building pack or (optional) assembly by ACD
- term of delivery: 5 weeks horticultural glass and safety glass + 2 weeks in RAL colour, + 2 weeks assembly by ACD.
- in this size we offer you **2 action models**:
  - o action model S104H (refer to p. 17): 3,06 m x 2,98 m
  - o action model S106H (refer to p. 19): 3,06 m x 4,45 m
- with as extra benefits:
  - o lower price
  - o delivery term 3 weeks + 2 weeks in RAL colour

Width 3,06 m	S103H	<b>S104H</b>	S105H	<b>S106H</b>	S107H	S108H	S109H	S110H
--------------	-------	--------------	-------	--------------	-------	-------	-------	-------

length	2.24 m	2.98 m	3.71 m	4.45 m	5.19 m	5.93 m	6.67 m	7.41 m
height of ridge (1)	2,37 m	2,37 m	2,37 m	2,37 m	2,37 m	2,37 m	2,41 m	2,41 m
height of gutter (2)	1,72 m	1,72 m	1,72 m	1,72 m	1,72 m	1,72 m	1,76 m	1,76 m
# roof windows	1	1	1	2	2	4	4	6
ground surface m <sup>2</sup>	6,85	9,12	11,35	13,62	15,88	18,15	20,41	22,68
glass surface m <sup>2</sup>	22,2	26,4	30,7	34,6	39,1	41,4	47,6	51,9

aluminium								
RAL colour								

assembly								
assembly accessories*								

\*During greenhouse assembly

# GREENHOUSE WITH SLOPING WALLS

**WIDTH 3,80 M - S2**

**HIGH MODEL**



Action model S208H

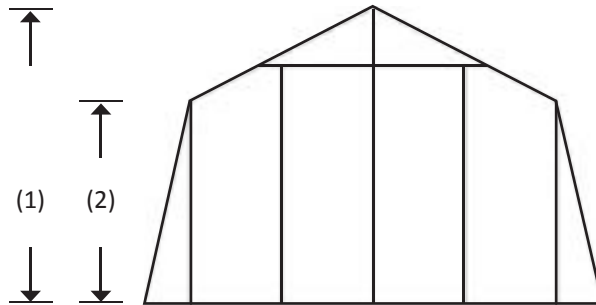

- advantages of sloping walls: refer to p. 16
- 1 front sliding door, width 0,68 m x height 1,85 m
- number of roof windows (0,78 m x 0,73 m) according to the length of your greenhouse (see table)
- standard hammered glass in the roof
- choice between 4 mm horticultural glass and 4 mm safety glass (EU-standard EN12150)
- rubber strips contribute to an airtight and watertight assembly
- self-supporting aluminium foundation = no concrete foundation required
- ground anchors included
- free home delivery
- 12 year manufacturer's guarantee
- each greenhouse can be delivered in the RAL colour you choose
- do-it-yourself building pack or (optional) assembly by ACD
- term of delivery: 5 weeks horticultural glass and safety glass + 2 weeks in RAL colour, + 2 weeks assembly by ACD
- in this size we offer you the **action model S208H** (refer to p. 21): 3,80 m x 5,93 m  
with as extra benefits:
  - o lower price
  - o Delivery term 3 weeks + 2 weeks in RAL colour

Width 3,80 m	S203H	S204H	S205H	S206H	S207H	<b>S208H</b>	S209H	S210H
--------------	-------	-------	-------	-------	-------	--------------	-------	-------

length	2.24 m	2.98 m	3.71 m	4.45 m	5.19 m	5.93 m	6.67 m	7.41 m
height of ridge (1)	2,53 m	2,53 m	2,53 m	2,53 m	2,53 m	2,53 m	2,57 m	2,57 m
height of gutter (2)	1,72 m	1,72 m	1,72 m	1,72 m	1,72 m	1,72 m	1,76 m	1,76 m
# roof windows	1	1	1	2	2	4	4	6
ground surface m <sup>2</sup>	8,51	11,32	14,10	16,91	19,72	22,53	25,35	28,16
glass surface m <sup>2</sup>	27,2	32,1	36,9	41,7	46,5	51,3	56,1	61,0

aluminium								
RAL colour								

assembly								
assembly accessories*								

\*During greenhouse assembly



## GREENHOUSE WITH SLOPING WALLS

**WIDTH 4,53 M - S3  
HIGH MODEL**

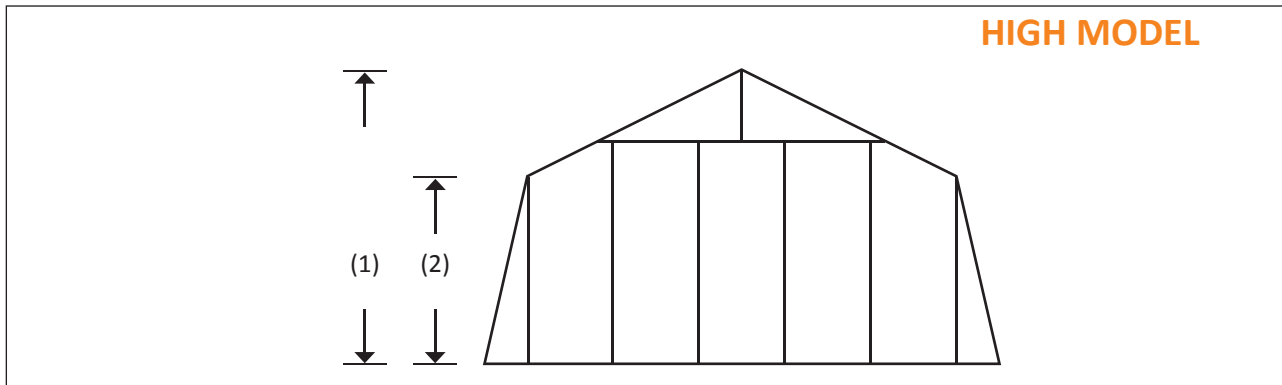

- advantages of sloping walls: refer to p. 16
- 1 front sliding door, width 0,68 m x height 1,85 m
- number of roof windows (0,78 m x 0,73 m) according to the length of your greenhouse (see table)
- standard hammered glass in the roof
- choice between 4 mm horticultural glass and 4 mm safety glass (EU-standard EN12150)
- rubber strips contribute to an airtight and watertight assembly
- self-supporting aluminium foundation = no concrete foundation required
- ground anchors included
- free home delivery
- 12 year manufacturer's guarantee
- each greenhouse can be delivered in the RAL colour you choose
- do-it-yourself building pack or (optional) assembly by ACD
- term of delivery: 5 weeks in horticultural glass / 10 weeks in safety glass / + 2 weeks in RAL colour, + 2 weeks assembly by ACD.

Width 4,53 m	S303H	S304H	S305H	S306H	S307H	S308H	S309H	S310H
--------------	-------	-------	-------	-------	-------	-------	-------	-------

length	2.24 m	2.98 m	3.71 m	4.45 m	5.19 m	5.93 m	6.67 m	7.41 m
height of ridge (1)	2,72 m	2,72 m	2,72 m	2,72 m	2,72 m	2,72 m	2,72 m	2,72 m
height of gutter (2)	1,76 m	1,76 m	1,76 m	1,76 m	1,76 m	1,76 m	1,76 m	1,76 m
# roof windows	1	2	2	3	4	5	6	7
ground surface m <sup>2</sup>	10,15	13,50	16,81	20,16	23,51	26,86	30,22	33,57
glass surface m <sup>2</sup>	34,7	40,1	45,5	50,9	56,3	61,7	67,1	72,5

aluminium								
RAL colour								

assembly								
assembly accessories*								

\*During greenhouse assembly

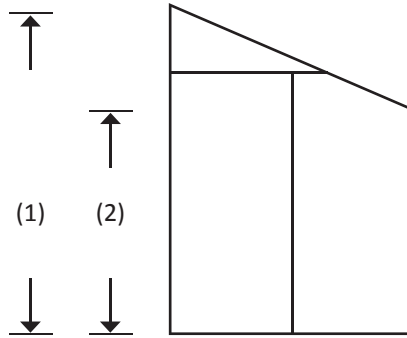

**NEW****LEAN-ON GREENHOUSE WITH STRAIGHT WALLS****DEPTH 1,55 M -MR2**

- 1 sliding door in the side wall, width 0,68 m x height 1,61 m (left of right wall)
- number of roof windows (0,78 m x 0,73 m) according to the length of your greenhouse (see table)
- standard hammered glass in the roof
- choice between 4 mm horticultural glass and 4 mm safety glass (EU-standard EN12150)
- rubber strips contribute to an airtight and watertight assembly
- self-supporting aluminium foundation = no concrete foundation required
- ground anchors included
- free home delivery
- 12 year manufacturer's guarantee
- each greenhouse can be delivered in the RAL colour you choose
- do-it-yourself building pack or (optional) assembly by ACD
- term of delivery: 5 weeks in horticultural glass / 10 weeks in safety glass / + 2 weeks in RAL colour, + 2 weeks assembly by ACD.
- this type of greenhouse does not come with a screen door
- gutter comes with rail = possibility to mount low door on the side wall

Depth 1,55 m	MR203H	MR204H	MR205H	MR206H	MR207H	MR208H	MR209H	MR210H
--------------	--------	--------	--------	--------	--------	--------	--------	--------

length	2.24 m	2.98 m	3.71 m	4.45 m	5.19 m	5.93 m	6.67 m	7.41 m
height of ridge (1)	2,60 m	2,60 m	2,60 m	2,60 m	2,60 m	2,60 m	2,60 m	2,60 m
height of gutter (2)	1,77 m	1,77 m	1,77 m	1,77 m	1,77 m	1,77 m	1,77 m	1,77 m
# roof windows	1	1	1	2	3	3	4	4
ground surface m <sup>2</sup>	3,47	4,62	5,75	6,90	8,04	9,19	10,34	11,49
glass surface m <sup>2</sup>	12,99	15,4	17,81	20,22	22,63	25,04	27,45	29,86

aluminium								
RAL colour								

assembly								
assembly accessories*								

\*During greenhouse assembly

**NEW**

**LEAN-ON GREENHOUSE WITH STRAIGHT WALLS**

**DEPTH 2,29 M - MR3**

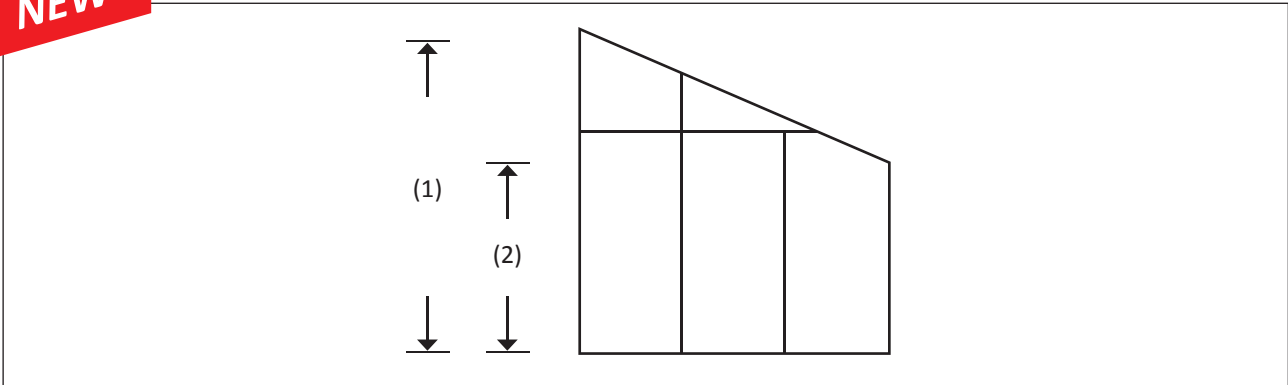

- 1 sliding door in the side wall, width 0,68 m x height 1,61 m (left of right wall)
- number of roof windows (0,78 m x 0,73 m) according to the length of your greenhouse (see table)
- standard hammered glass in the roof
- choice between 4 mm horticultural glass and 4 mm safety glass (EU-standard EN12150)
- rubber strips contribute to an airtight and watertight assembly
- self-supporting aluminium foundation = no concrete foundation required
- ground anchors included
- free home delivery
- 12 year manufacturer's guarantee
- each greenhouse can be delivered in the RAL colour you choose
- do-it-yourself building pack or (optional) assembly by ACD
- term of delivery: 5 weeks in horticultural glass / 10 weeks in safety glass / + 2 weeks in RAL colour, + 2 weeks assembly by ACD.
- this type of greenhouse does not come with a screen door
- gutter comes with rail = possibility to mount low door on the side wall

Depth 2,29 m	MR303H	MR304H	MR305H	MR306H	MR307H	MR308H	MR309H	MR310H
--------------	--------	--------	--------	--------	--------	--------	--------	--------

length	2.24 m	2.98 m	3.71 m	4.45 m	5.19 m	5.93 m	6.67 m	7.41 m
height of ridge (1)	2,97 m	2,97 m	2,97 m	2,97 m	2,97 m	2,97 m	2,97 m	2,97 m
height of gutter (2)	1,77 m	1,77 m	1,77 m	1,77 m	1,77 m	1,77 m	1,77 m	1,77 m
# roof windows	1	1	1	2	3	3	4	4
ground surface m <sup>2</sup>	5,13	6,82	8,50	10,19	11,89	13,58	15,27	16,97
glass surface m <sup>2</sup>	18,7	21,75	24,8	27,85	30,9	33,95	37	40,05

aluminium								
RAL colour								

assembly								
assembly accessories*								

\*During greenhouse assembly

# LEAN-ON GREENHOUSE WITH SLOPING WALLS

DEPTH 1,99 M - MS1

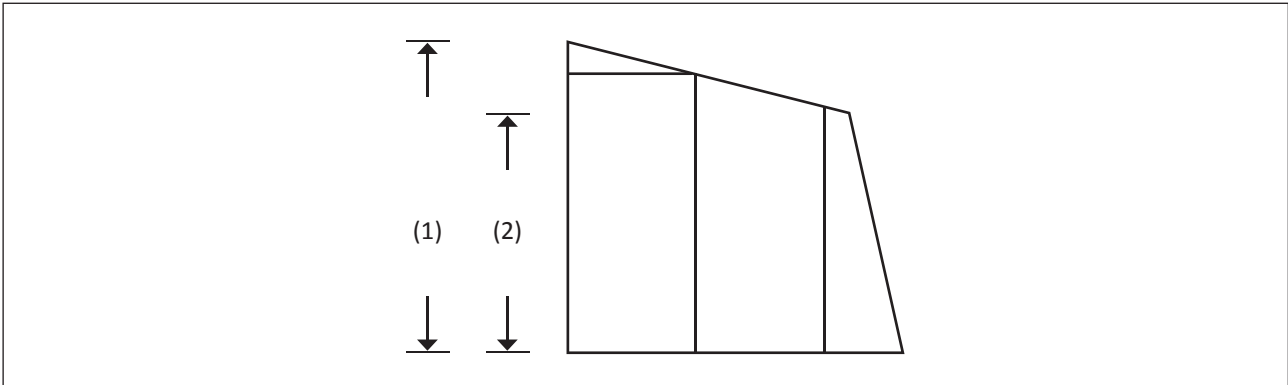

- 1 sliding door in the side wall, width 0,66 m x height 1,55 m (left of right wall) - MS1
- 1 sliding door in the side wall, width 0,66 m x height 1,80 m (= MS2/3), if door is mounted against the wall
- 1 sliding door in the side wall, width 0,68 m x height 1,80 m (= MS2/3)
- number of roof windows (0,78 m x 0,73 m) according to the length of your greenhouse (see table)
- standard hammered glass in the roof
- choice between 4 mm horticultural glass and 4 mm safety glass (EU-standard EN12150)
- rubber strips contribute to an airtight and watertight assembly
- self-supporting aluminium foundation = no concrete foundation required
- ground anchors included
- free home delivery
- 12 year manufacturer's guarantee
- each greenhouse can be delivered in the RAL colour you choose
- do-it-yourself building pack or (optional) assembly by ACD
- term of delivery: 5 weeks in horticultural glass / 10 weeks in safety glass / + 2 weeks in RAL colour, + 2 weeks assembly by ACD.
- this type of greenhouse does not come with a screen door
- gutter comes with rail = possibility to mount low door on the side

Depth 1,99 m	MS103L	MS104L	MS105L	MS106L	MS107L	MS108L	MS109L	MS110L
--------------	--------	--------	--------	--------	--------	--------	--------	--------

length	2.24 m	2.98 m	3.71 m	4.45 m	5.19 m	5.93 m	6.67 m	7.41 m
height of ridge (1)	1,99 m	1,99 m	1,99 m	1,99 m	1,99 m	1,99 m	2,03 m	2,03 m
height of gutter (2)	1,50 m	1,50 m	1,50 m	1,50 m	1,50 m	1,50 m	1,54 m	1,54 m
# roof windows	1	1	1	2	3	3	4	4
ground surface m <sup>2</sup>	4,46	5,93	7,38	8,86	10,33	11,80	13,27	14,75
glass surface m <sup>2</sup>	12,9	15,1	17,4	19,6	21,8	24,1	26,3	28,5

aluminium								
RAL colour								

assembly								
assembly accessories*								

\*During greenhouse assembly

## LEAN-ON GREENHOUSE WITH SLOPING WALLS

DEPTH 2,28 M - MS2

Depth 2,28 m	MS203H	MS204H	MS205H	MS206H	MS207H	MS208H	MS209H	MS210H
length	2.24 m	2.98 m	3.71 m	4.45 m	5.19 m	5.93 m	6.67 m	7.41 m
height of ridge <sup>(1)</sup>	2,43 m	2,43 m	2,43 m	2,43 m	2,43 m	2,43 m	2,47 m	2,47 m
height of gutter <sup>(2)</sup>	1,72 m	1,72 m	1,72 m	1,72 m	1,72 m	1,72 m	1,76 m	1,76 m
# roof windows	1	1	1	2	3	3	4	4
ground surface m <sup>2</sup>	5,11	6,79	8,46	10,15	11,83	13,52	15,21	16,89
glass surface m <sup>2</sup>	15,31	17,93	20,55	23,17	25,79	28,41	31,03	33,65

aluminium								
RAL colour								

assembly								
assembly accessories*								

\*During greenhouse assembly

## LEAN-ON GREENHOUSE WITH SLOPING WALLS

DEPTH 3,02 M - MS3

Depth 3,02 m	MS303H	MS304H	MS305H	MS306H	MS307H	MS308H	MS309H	MS310H
length	2.24 m	2.98 m	3.71 m	4.45 m	5.19 m	5.93 m	6.67 m	7.41 m
height of ridge <sup>(1)</sup>	3,05 m	3,05 m	3,05 m	3,05 m	3,05 m	3,05 m	3,05 m	3,05 m
height of gutter <sup>(2)</sup>	1,76 m	1,76 m	1,76 m	1,76 m	1,76 m	1,76 m	1,76 m	1,76 m
# roof windows	1	1	1	2	3	3	4	4
ground surface m <sup>2</sup>	6,76	9,00	11,20	13,44	15,67	17,91	20,14	22,38
glass surface m <sup>2</sup>	21,8	25,1	28,3	31,6	34,9	38,2	41,5	44,8

aluminium								
RAL colour								

assembly								
assembly accessories*								

\*During greenhouse assembly

## **Delivery of the greenhouse without assembly:**

### **1.1 The delivery:**

- The transporter shall contact the customer in order to confirm the date of delivery.
- The place of delivery must be accessible for heavy transport (truck W2m70/H4m20/L 18m).
- The boxes containing the frame of the greenhouse shall be unloaded manually.  
The glass case is unloaded by transpallet.
- The goods shall be delivered on the footway, provided it is easily accessible.
- The customer must provide helping hands for unloading the greenhouse (box/glass case).
- The packaging shall not be taken back. If these conditions are not met, extra costs shall be charged to the customer.

### **1.2 Damages or delivery of wrong parts:**

- Visible damage of the packaging and/or of the goods must be reported immediately and in a detailed way on the delivery document of the transporter.
- The goods, even if damaged, must always be received.
- Invisible damage and invalid deliveries must be reported within 24 hours after receipt of the goods and in written to your selling point! Afterwards, we shall take the necessary steps to replace the damaged items or to send you new items.
- For a better management of the claim, it is important to point out in the manual the missing/damaged/invalid items when you report them to your selling point.

### **1.3 Storage of the greenhouse:**

While the boxes with the frame and the glass case are waiting to be assembled, it is important to store them in a dry and protected area. When the packaging is exposed to rain and excessive sun radiation, the greenhouse may be irreversibly damaged (window panes may stick together, the glass may get stained, traces of glue etc.).

### **1.4 Dimensions and weight of the action models:**

<b>Model</b>	<b>Type</b>	<b>Weight</b>	<b>Dimensions</b>	<b>Number of ground anchors</b>
Piccolo	Box frame Glass case	51kg 160kg	2700mm x 410mm x H 260mm 1750mm x 800mm x H 1270mm	4 (1 in each corner)
R204L-B	Box frame Glass case	62kg 227kg	3150mm x 410mm x H 260mm 1750mm x 800mm x H 1270mm	4 (1 in each corner)
R305H-B	Box frame Glass case	82kg 363kg	3900mm x 410mm x H 260mm 1750mm x 800mm x H 1270mm	4 (1 in each corner)
R307H-B	Box frame 1 Box frame 2 Glass case	72kg 29kg 458kg	3150mm x 410mm x H 260mm 5330mm x 240mm x H 110mm 1750mm x 800mm x H 1270mm	6 (1 in each corner and 2 half way in the length)
S104H-B	Box frame Glass case	72kg 265kg	3150mm x 410mm x H 260mm 1750mm x 800mm x H 1270mm	4 (1 in each corner)
S106H-B	Box frame 1 Box frame 2 Glass case	64kg 25kg 349kg	3150mm x 410mm x H 260mm 4600mm x 240mm x H 110mm 1750mm x 800mm x H 1270mm	4 (1 in each corner)
S208H-B	Box frame 1 Box frame 2 Glass case	87kg 34kg 539kg	3900mm x 410mm x H 260mm 6050mm x 240mm x H 110mm 1750mm x 800mm x H 1270mm	6 (1 in each corner and 2 half way in the length)
R205H RETRO	Box frame Glass case	76kg 274kg	3900mm x 410mm x H 260mm 1750mm x 800mm x H 1270mm	4 (1 in each corner)
R306H RETRO	Box frame 1 Box frame 2 Glass case	70kg 26kg 410kg	3900mm x 410mm x H 260mm 6050mm x 240mm x H 110mm 1750mm x 800mm x H 1270mm	4 (1 in each corner)
R405H RETRO	Box frame Glass case	119kg 474kg	3900mm x 410mm x H 260mm 1750mm x 800mm x H 1270mm	4 (1 in each corner)

### **1.5 Tips during the construction of the greenhouse:**

- It is important to follow all instructions of the manual.
- Please make sure, before starting the assembly, that the ground surface is flat and obstacle free.
- These tools may be useful: rubber suction cups for glass, gloves, turn screw etc.
- If you intend to mount the greenhouse on full ground, we advise to provide +/- 12kg concrete per ground anchor
- Assemble the greenhouse step by step, as chronically indicated in the manual.
- If the greenhouse is mounted on a walled base or concrete foundation, L-shaped profiles, plugs and screws for anchoring purposes can be delivered. Please mention it on the order form.
- Do not forget to inform your Insurance company about the acquisition of your greenhouse.

## Order with assembly by ACD:

### 1.1 Accessibility of the place of delivery:

ACD shall contact the customer in order to confirm the date of delivery. The address of delivery must be accessible for heavy transport (truck W2m70/H4m20/L 18m).

If the address of delivery has difficult access, please mention it when you order the greenhouse.

### 1.2 Reachability and accessibility of the place of assembly:

The greenhouse is delivered in pre-mounted panels. De kleinste vrachtwagen waarmee we kunnen leveren is een citytrailer van 11 m. A minimal passage of 1 m (width) and 2.85m (height) is required. The maximal length of the panels is equal to the length of the ordered greenhouse.

Should the place of assembly not be reachable or accessible, please mention it on the order form.

### 1.3 Preparation of the assembly:

Before the assembly of the greenhouse, the customer must make sure that the building area is:

- flat (horizontal)
- stable (frost free / dry / not digged)
- constructible (obstacle free / underground minimum 30 cm top soil)

If the conditions are not met, the assembly shall be suspended and a second assembly turn shall be invoiced. Extra cost, if any, shall be invoiced to the customer.

### 1.4 Anchorage of a ACD® PRESTIGE greenhouse:

Anchorage of the greenhouse on full ground:

ACD provides for concrete casting around the foundation anchors.

Anchorage of the greenhouse on an existing concrete foundation of walled support:

- For a solid fixation of the greenhouse the upper 10 cm of the foundation must be solid. In such case, L-shaped profiles, plugs and screws shall be delivered.
- When the greenhouse is mounted on a walled support, the extended height of one or more doors shall be suggested on a sketch by, including the dimensions of the walled support. The order shall be started up only if the sketch is returned duly signed to ACD

### 1.5 Assembly of an ACD® PRESTIGE lean-to greenhouse:

The building wall must be flat and vertical.

The drawing alongside shows which area of the wall must be sufficiently flat and even to fix the greenhouse.

The soil must be flat and perpendicular (90°) to the wall the greenhouse leans to.

When ordering a lean-to greenhouse, the customer must always join a photograph of the place of assembly



## 2 Terms of delivery of ACD® PRESTIGE greenhouses:

The term of delivery starts upon receipt of the complete order. The terms of delivery are not binding and exceeding these terms can in no way give rise to undo the order.

Type of greenhouse	Standard term of delivery	Extra term of delivery safety glass	Extra term of delivery coating	Extra term of delivery assembly
Action model on stock - uncoated	+/- 3 weeks	-	+ 2 weeks	+ 2 weeks
Action model on stock coated RETRO RAL 9005	+/- 3 weeks	-	-	+ 2 weeks
Greenhouse made to measure	+/- 5 weeks	+ 5 weeks	+ 2 weeks	+ 2 weeks



## **General terms and conditions of sale**

1. The present general sales terms and conditions shall entirely and without restrictions apply to any sales agreement concluded with ACD, unless otherwise agreed upon in written between the seller and the customer, if any. The general sales terms and conditions prevail as of right over the purchase terms and conditions of the purchaser. The nullity of one or several clauses of the present terms and conditions, if any, does not impair the applicability of all other clauses.
2. All prices are calculated 'off warehouse' at the registered office of the seller. The delivery occurs by handing over the goods directly to the purchaser, either by handing over the goods directly to the purchaser, either by handing over the goods by a transporter or forwarding agent. The risk is transferred to the purchaser upon delivery. The goods travel at the risk of the consignee, even in case of franco delivery. Costs for transport, storage, Insurance etc. are not included, unless otherwise mentioned.
3. If costs, in part or in total, which influence the price due to circumstances beyond the control of ACD, ACD shall be entitled to invoice a proportionate price increase to the customer after simple communication to the customer. Unless otherwise explicitly agreed upon in written between ACD and the customer, the prices are considered to apply to the goods without packaging. The indicated prices and numbers are based on the data and numbers communicated by the customer. If certain data, communicated by the customer and which is important for the price determination, do not appear to comply with the reality, ACD shall be entitled to modify unilaterally and accordingly the price agreed upon or to cancel the agreement as of right, at the expense of the customer.
4. The dimensions, characteristics, materials, colours and other data referred to in the catalogues, brochures, advertising, folders, price lists, website and other documents edited by ACD are not compelling for ACD and are communicated for mere information.
5. Complaints in connection with defaults shall be receivable only when they have been made by registered mail within one (1) week of discovery and at the latest within one month after delivery of the goods. Complaints related to visible defaults are no longer admitted after delivery and acceptance of the goods.
6. Complaints related to mere invoicing shall be communicated by registered mail to the seller no later than five (5) working days after the date of invoice.
7. The responsibility of the seller cannot be invoked when the non-compliance with the commitments is due to acts of God, including yet not limited to war, conflicts, partial or complete strike, partial or overall lock-out, contagious diseases, exploitation accidents, fire etc. Acts of God suspend the terms of delivery and do not entitle the purchaser to cancel the agreement.
8. In case of non-complying delivery or in case of an admissible complaint in connection with hidden defects, the responsibility of the seller shall be limited to the substitution of the merchandise or to the restitution of the price the customer has paid for the merchandise, as decided by the seller. In such event, the seller shall not be liable to pay any compensation or any sanction whatsoever. The contractual term of delivery and the technical characteristics are mentioned only approximately, unless otherwise referred to, and shall not bind the seller. A delay in delivery, if any, can never result in the annulment of the agreement or in payment of compensation.
9. The purchase shall collect an order within the agreed term of delivery. If a customer cancels the agreement or does not comply with the contractual obligations, ACD shall be entitled to cancel the existing agreement immediately and as of right, costs to be paid by the customer. In such event the customer shall owe, as a lump sum compensation, an amount of fifty (50) per cent of the agreed price of the cancelled agreement, without prejudice to the right of ACD of proving higher damage and without prejudice to the right of ACD to claim the forced enforcement of the agreement. The dissolution of the agreement occurs as of right and without previous notice or judicial intervention, by mere notification by registered mail.
10. If the confidence of ACD in the creditworthiness of the customer is compromised (e.g. due to summons in bankruptcy, seizure, designation of a judicial trustee, etc.), ACD reserves itself the right, even if the goods have been shipped, partially or completely, either to cancel the entire agreement as of right or to suspend its realisation and to claim further guarantees from the customer. If the customer fails to comply, ACD reserves itself the right to cancel the entire agreement as of right, at the expense of the customer.
11. Reserve of property: the goods remain the property of the seller until the moment of full payment of their price. All risks are at the expense of the purchaser. The down payments remain acquired to the seller in order to compensate possible losses due to resale. The purchaser undertakes not to resell, to pledge or to alienate the merchandise as long as it is the property of the seller. The purchaser shall immediately inform the seller of any event of seizure, theft or other circumstances which might compromise the property rights of the seller over the goods. The purchaser shall return the goods upon first request of the seller if no full payment has been made on the maturity date.
12. All invoices shall be paid at the registered office of the seller. All costs related thereto shall be at the full expense of the purchaser.
13. Unless otherwise agreed upon in written, the invoices shall mature no later than thirty (30) days after the date of invoice. During the execution of an order, the seller shall always be entitled to claim guarantees in order to safeguard the payment. If the purchaser fails to establish the required guarantees, the seller reserves himself the right to take all measures he feels necessary in order to safeguard his interests.
14. In case of non-payment at the maturity date, all outstanding invoices shall produce, as of right and without previous notice, a moratory interest of ten (10) per cent per year as from the date of invoice. In case of full or partial non-payment of an invoice at the maturity date, the outstanding amount shall be increased as of right with ten (10) per cent of the invoiced amount, yet with a minimum of € 400,00 and a maximum of € 2.500,00, even when delayed payment has been granted. The non-payment at the maturity date of one single invoice makes all the other outstanding invoices immediately claimable as of right. All agreements between ACD and the customer make part of one global contractual relationship. If the customer fails to comply with the commitments of an agreement, ACD shall have the choice to suspend either the agreement concerned and/or all current agreements.
15. All guarantee claims lapse in case of:
  - improper use of the products delivered by ACD;
  - defects due to an abusive intervention of the customer or of third parties;
  - late information of defaults, according to what precedes;
  - small deviations in colour and dimensions.
16. All intellectual and industrial property rights in connection with drawings, designs, calculations, models, displays and other works made by ACD remain the exclusive property of ACD. Drawings, models and other commercial documents can be used by the customer only in the context of the execution of the agreement between parties; consequently, the documents or items concerned cannot be used nor copied by the customer or third parties without the written consent of ACD.
17. In case of dispute between the purchaser and the seller, only the courts of the judicial district of Kortrijk (Belgium) shall be competent (if the dispute falls under the competence of the Justice of the Peace, the Judge of the Peace of Roeselare (Belgium) shall be competent, subject to the right of ACD to summon the purchaser before the judge of the latter's place of residence. The agreement is exclusively governed by Belgian law, the Convention on Contracts for the International Sale of Goods of 11 April 1980 being excluded.

## ACD® GROW – STORE – EXPERIENCE

ACD® nv is family company which has been operating on the European hobby and do-it-yourself market for over 28 years. We focus on the “grow-store-experience” universum with products as greenhouses & accessories, temporary shelters, carports and patio coverings. ACD® has 3 main pillars: grow, store and experience.

### ACD® greenhouses & accessories

ACD® supplies everything you need inside and outside your greenhouse. The greenhouse is made to measure according to the ambitions you have in your vegetable garden. ACD® manufactures amongst others the own brand ACD® PRESTIGE, which has been extensively explained to you in this catalogue. For the “grow” pillar ACD® relies on a large dealer network all over Belgium, France and the Netherlands.



### Comfortroof International®

ACD® commercialises with Comfortroof International® multifunctional, mobile constructions which can be used as shelter, garage, carport, motor and bicycle shelter, hide for farm animals, storage room for firewood etc. For companies we develop quick, economic, flexible and premium solutions for issues of permanent or temporary lack of space.



#### More information?

[www.acd.eu](http://www.acd.eu)

[www.comfortroof.be](http://www.comfortroof.be)

T 0032 51 24 25 26

ACD nv

Zwaikomstraat 22

8800 Roeselare

Belgium



*Koen, production operator:*

*" We manufacture everything we can, even the glass nursing trays. With an ACD® PRESTIGE greenhouse, you buy a greenhouse of Belgian premium quality".*

SERVICE CENTER

[www.acd.eu](http://www.acd.eu)

Editor: ACD sa Zwaalkomstraat 22 B-8800 Roeselare Belgium T. 0032 (0)51 24 25 26

Version 20150115-CAT15 ENG

The photographs are not contractual. The greenhouse accessories you may see on the photographs are optional and are not included in the price of the greenhouse. Measures are approximative. All reproductions, in whole or in part, are forbidden.

ENG